

**PRACTICAL MANUAL**

**Insect Pests of Fruit, Plantation,  
Medicinal and Aromatic Crops**

**HPP- 230 3(2+1)**

**For undergraduate students in Horticulture**



**Dr. Vijay Kumar Mishra  
Dr. M. Soniya Devi  
Dr. Usha**

**2020**

**DEPARTMENT OF ENTOMOLOGY  
College of Agriculture  
RANI LAKSHMI BAI CENTRAL AGRICULTURAL UNIVERSITY  
JHANSI - 284003**

**Syllabus: Insect Pests of Fruit, Plantation, Medicinal and Aromatic Crops [ HPP- 230 3(2+1)**

Study of symptoms of damage, collection, identification, preservation, assessment of damage and population of important insect – pests affecting fruits, plantation, medicinal and aromatic crops in field and storage.

Name of Student .....

Roll No. ....

Batch .....

Session .....

Semester .....

Course Name : .....

Course No. : .....

Credit .....

Published: 2020

No. of copies: .....

Price: Rs.

©RLBCAU, Jhansi

---

**CERTIFICATE**

This is to certify that Shri./Km. ....ID No..... has completed the practical of course.....course No. .... as per the syllabus of B.Sc. (Hons.) Agriculture/ Horticulture/ Forestry ..... semester in the year.....in the respective lab/field of College.

Date:

Course Teacher

## INDEX

S. No.	Title	Page No
1	To study about types of damage of plants by different insect pest	
2	To study about the sampling techniques for the assessment of insect population and damage	
3	Collection, identification and preservation of insect pests	
4	To study about the major insect pests of mango	
5	To study about the bio-ecology and management mango mealy bug	
6	To study about the insect pests of guava and their damage symptoms	
7	Identification of insect pests of citrus and their damage symptoms	
8	To study about the anar butterfly in pomegranate	
9	To study about the insect pest of ber	
10	To study about the key pest of banana plantation	
11	To study about the major insect pest of aonla	
12	IPM module for management of major insect pest of fig	
13	To study major pests of coconut and arecanut	
14	To study major pests of tea and coffee	
15	To study insect pests of rubber and cocoa	
16	To study insect pests of betel vine and cashew	
17	To get well acquainted with pesticide application techniques	
18	To study calculation of insecticide doses	





**Draw the diagram damage caused by Rasping and sucking insect pests**

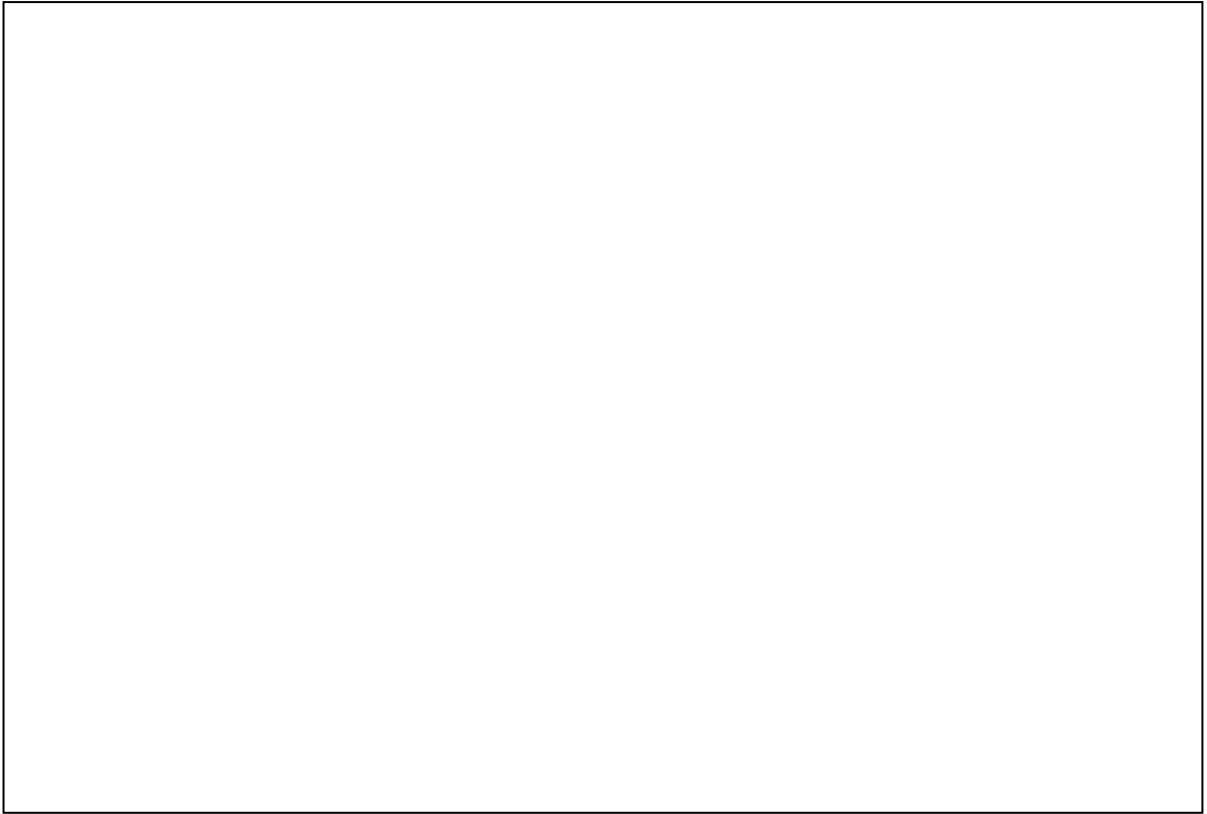













**Draw the diagram of equipment which are used during collection insect pests**

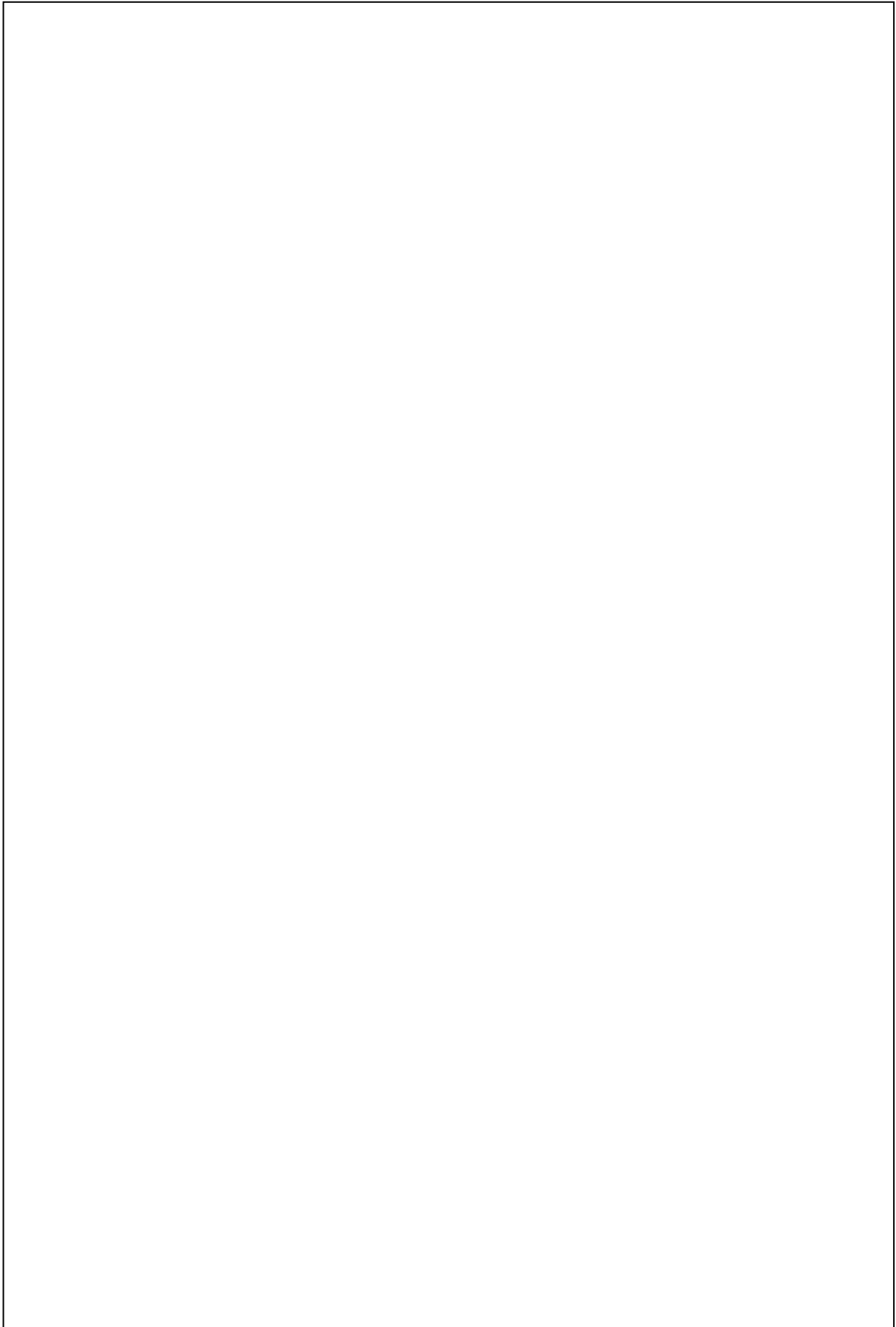

## Experiment No: 4

### Objective - To study about the major insect pests of mango

**Exercise** -To Visit mango orchard and identify the major insect pests of mango and their nature damage and damaging symptoms

#### Enlist of Major Insect Pest of Mango

Common Name	Scientific Name	Damaging Stage	Family	Order	Field diagnosis

Identify the four major insect pests of mango and their and damaging symptoms

S. No.	Insect particulars	Marks of identification	Damaging symptoms of	Observation



.....

.....

.....

.....

.....

.....

.....

**Draw the life cycle of mango mealy bug**

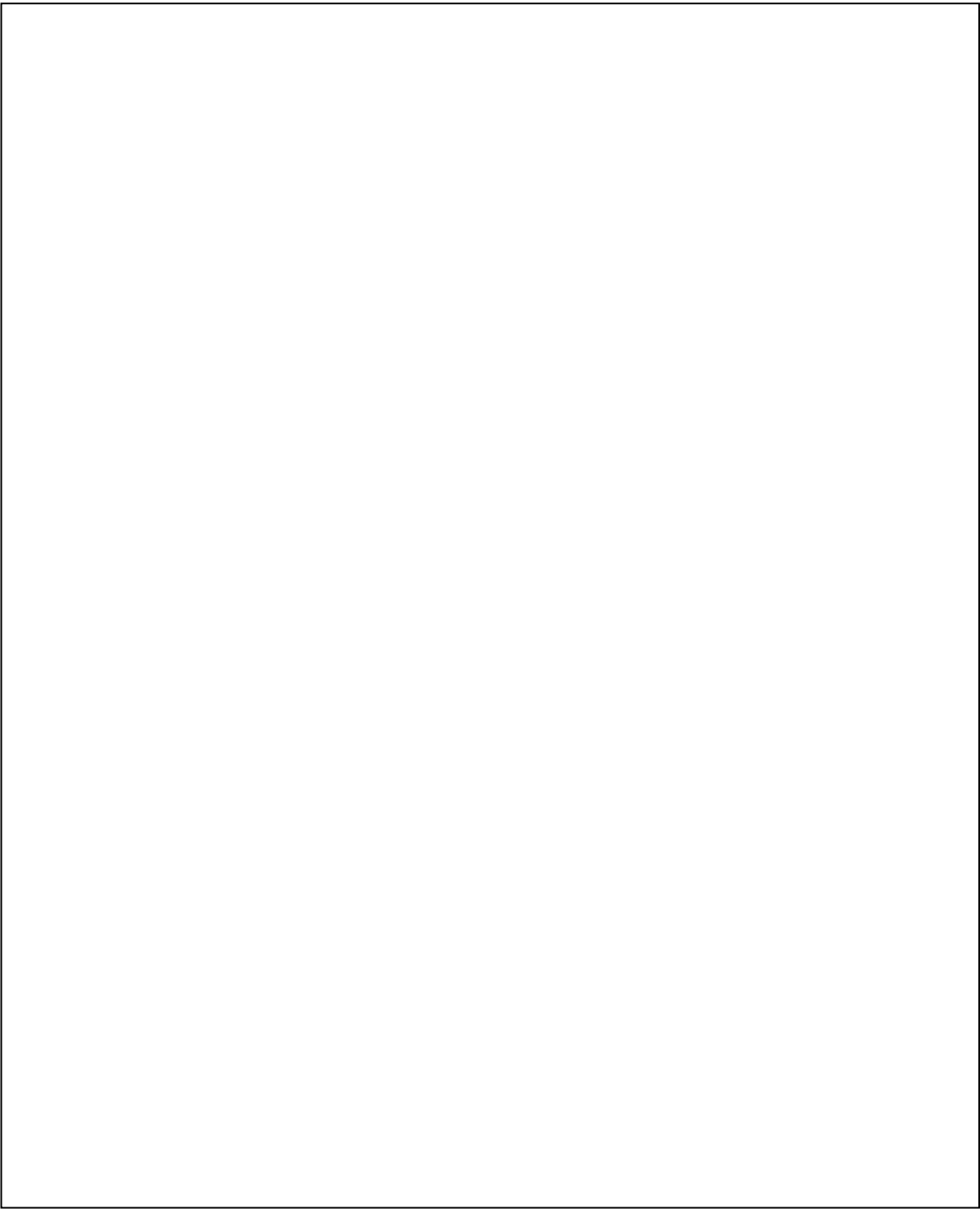





.....

.....

.....

.....

.....

**Draw the damaging symptoms**

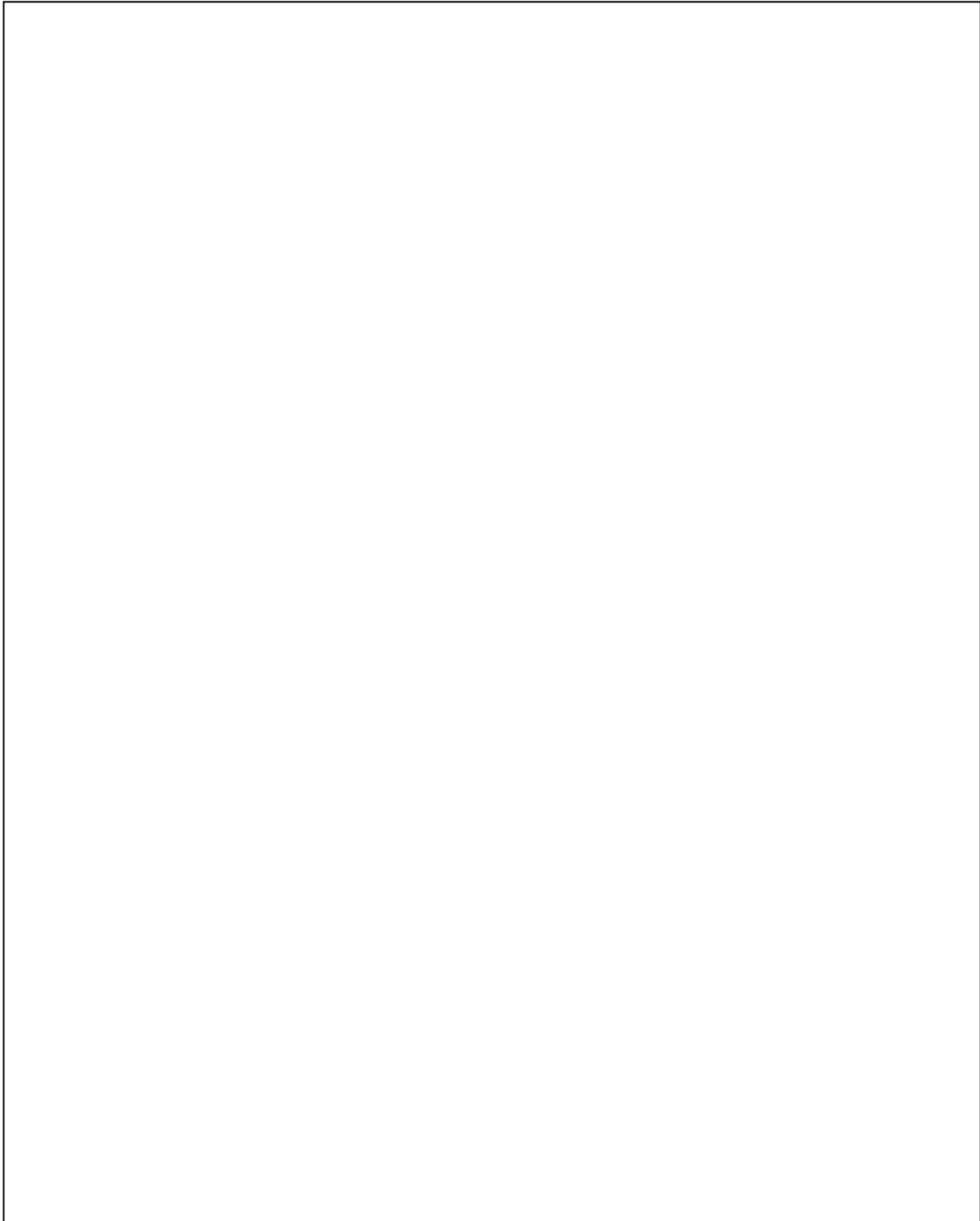

**Experiment No: 7**

**Objective - Identification of insect pests of citrus and their damage symptoms**

**Exercise -** To visit citrus orchard site and enlist important pest attacking on citrus orchard. Draw damaging symptoms and it's the life cycle of lemon butterfly.

**Enlist of insect pest of citrus**

S.No.	Common Name	Scientific Name	Family	Order	Observation

**Draw damage symptoms caused by lemon butterfly**

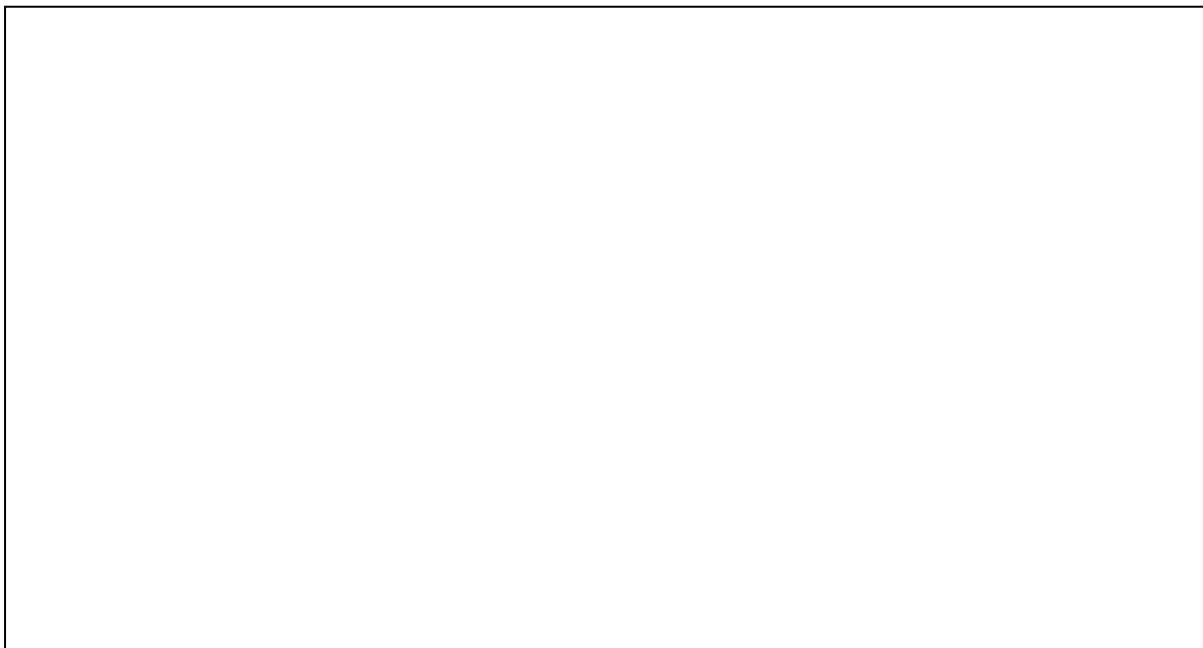

**Draw the diagram of life cycle**

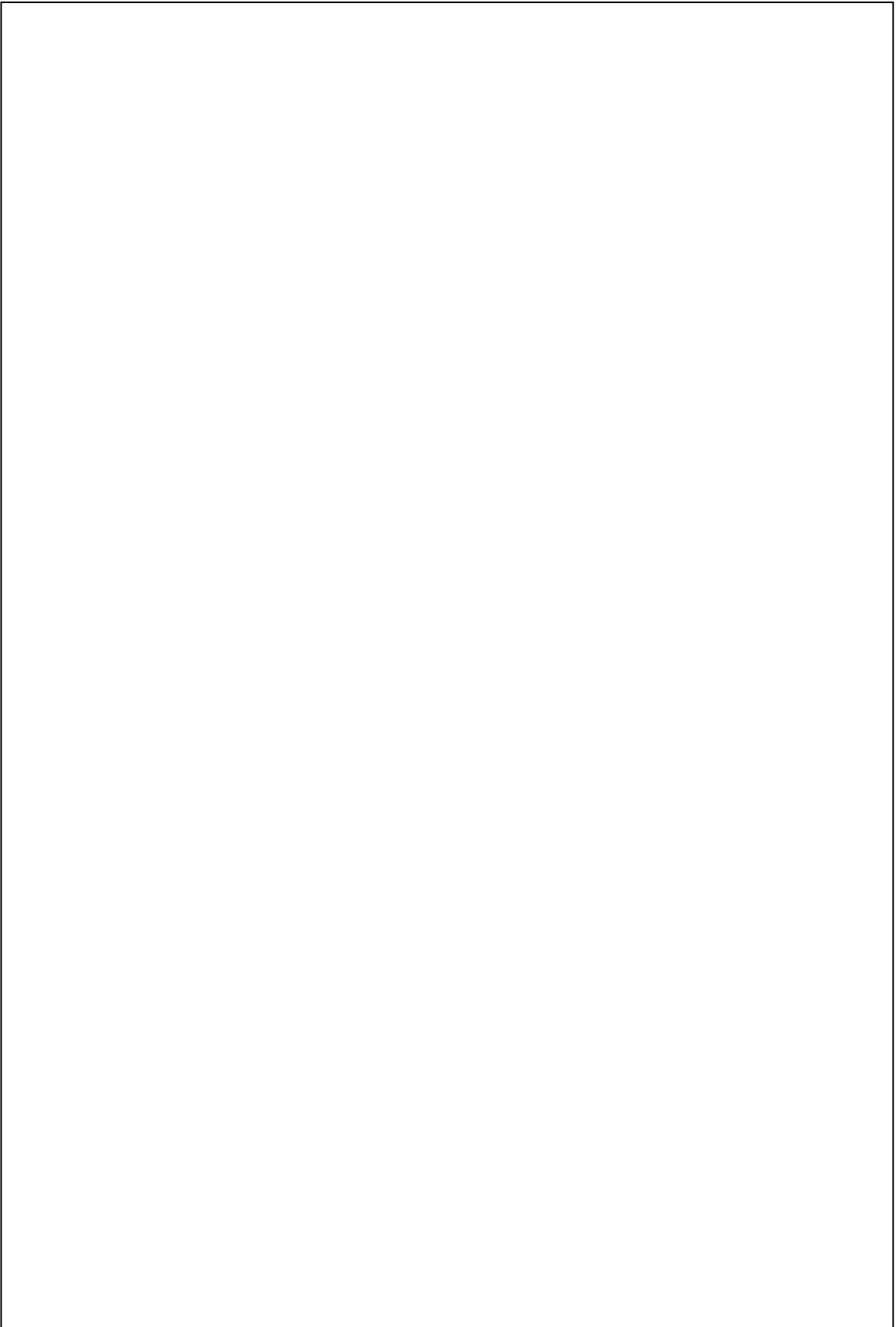







.....

.....

.....

.....

.....

**Draw the neat and well labeled diagram of life cycle of ber fruit fly**

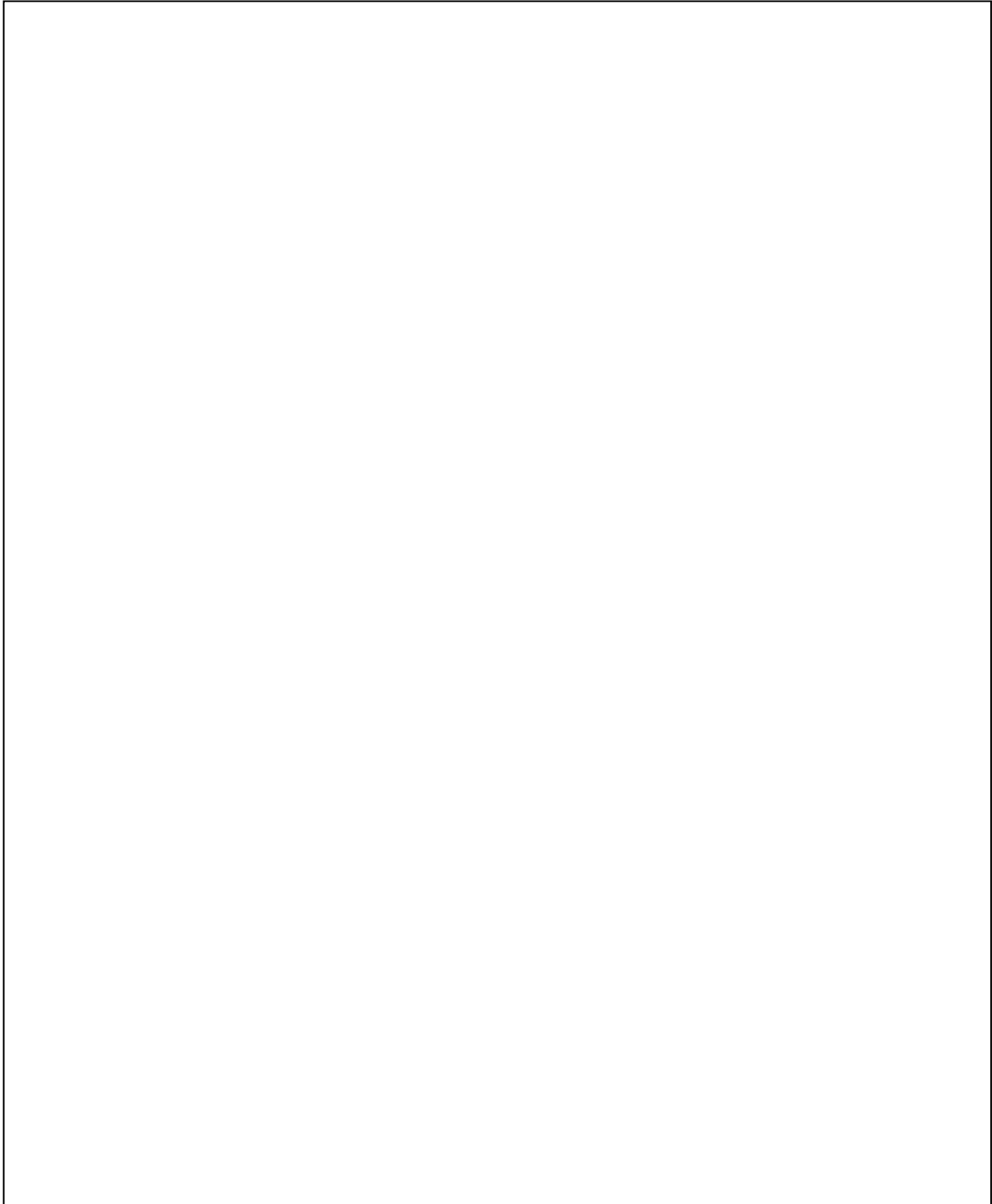





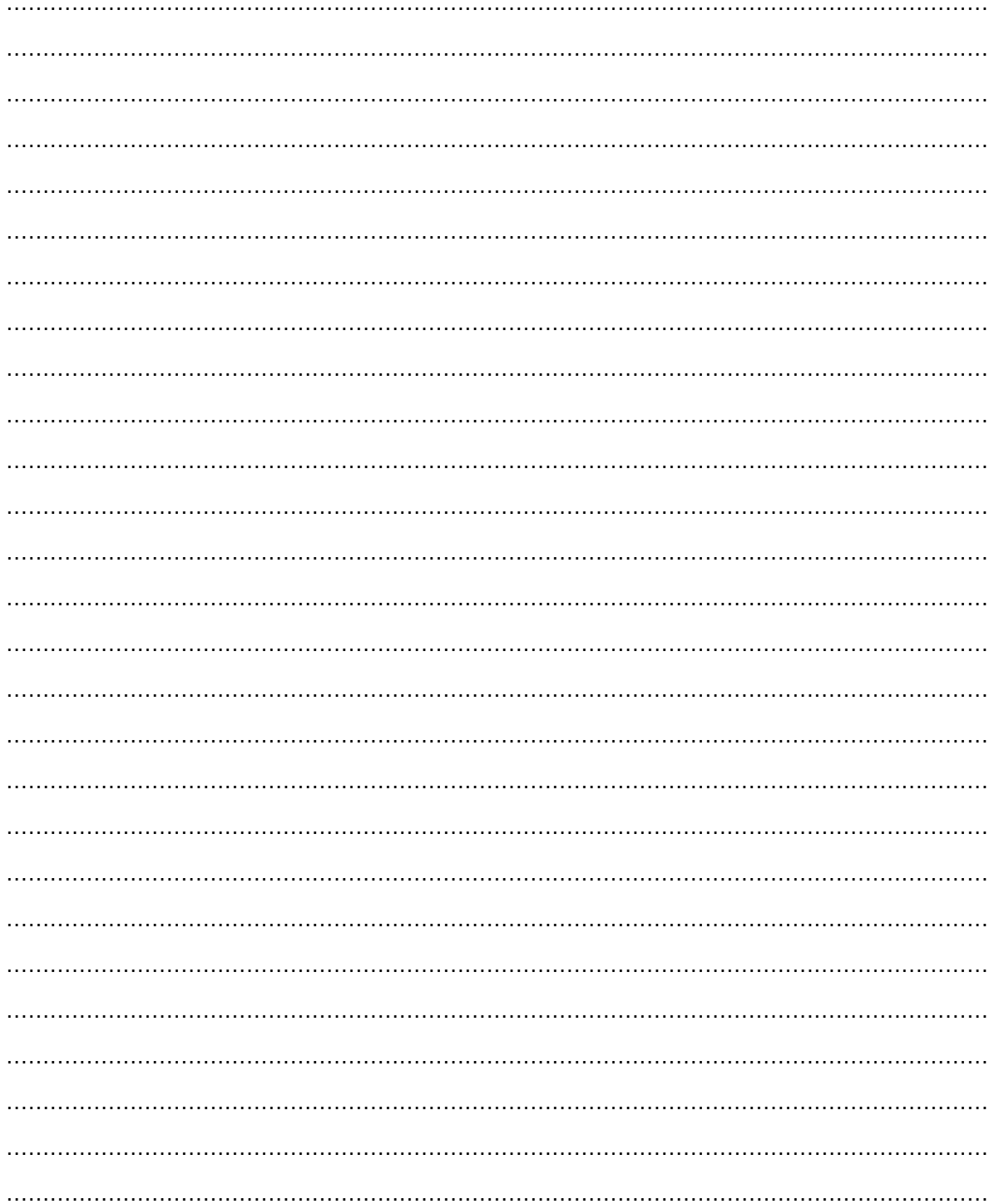

## Experiment No: 11

**Objective - To study about the major insect pest of aonla**

**Exercise -** To observe and enlist of major insect pest of aonla. Draw the damaging symptoms of shoot gall maker

**Enlist of major insect pest of aonla**

S. No	Common name	Scientific name	Family	Order	Observation

**Draw the damaging symptoms of shoot gall maker**





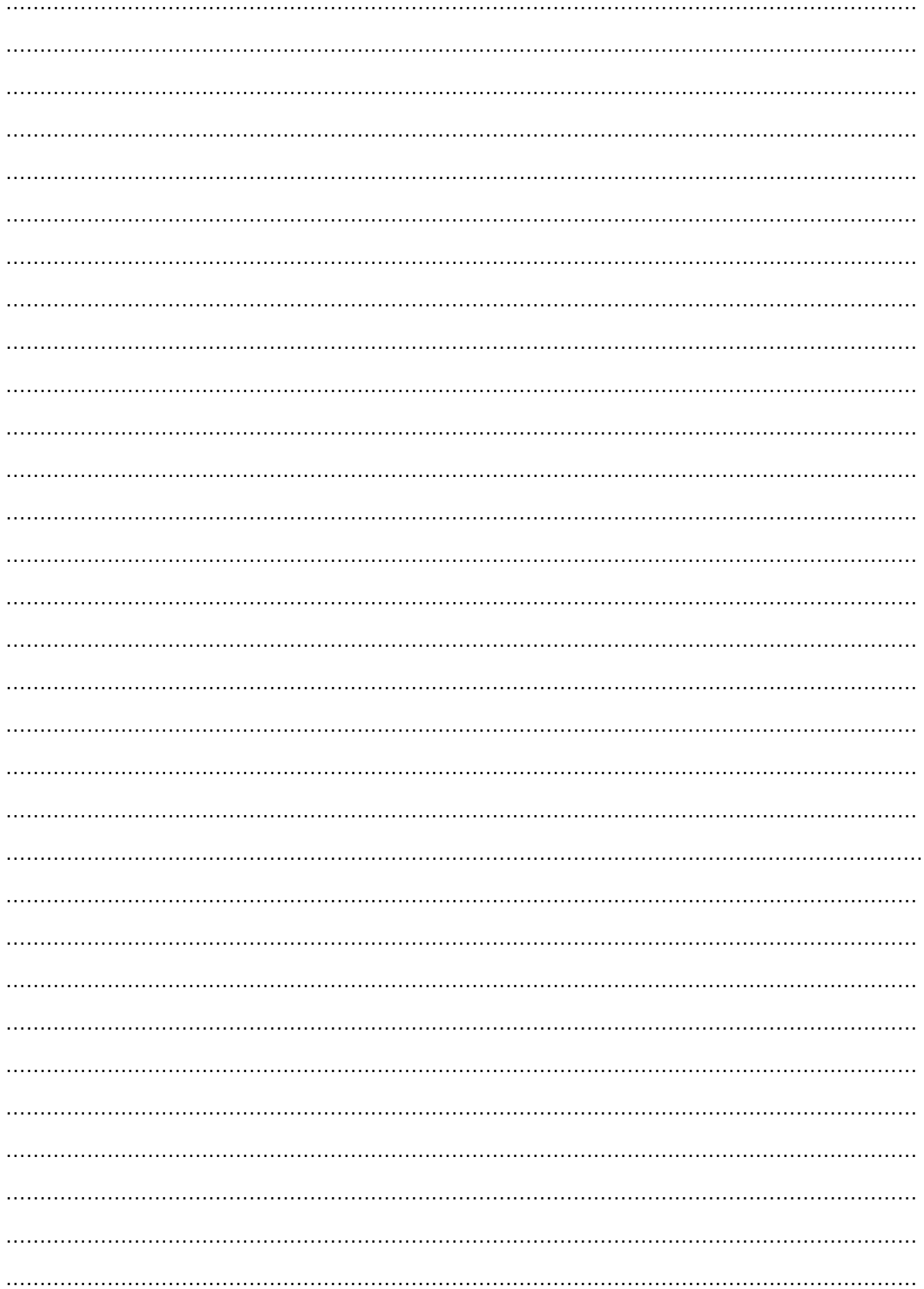

**Objective -To study major pests of coconut and arecanut**

**Exercise -Observe and enlist important pest attacking coconut and arecanut. Draw the life cycle of rhinoceros beetle and its damaging symptoms.**

Common name	Scientific name	Family & Order	Damaging symptoms
<b>Pest of Coconut</b>			
Rhinoceros beetle	..... .....	..... .....	..... ..... .....
Red palm weevil	..... .....	..... .....	..... ..... .....
Black headed caterpillar	..... .....	..... .....	..... ..... .....
Coconut Eriophyid mite	..... .....	..... .....	..... ..... .....
<b>Pest of Arecanut</b>			
Spindle bug	..... .....	..... .....	..... ..... .....
Palm or red mite	..... .....	..... .....	..... ..... .....
Root grub	..... .....	..... .....	..... ..... .....
Inflorescence Caterpillar	..... .....	..... .....	..... ..... .....

## Life cycle of rhinoceros beetle

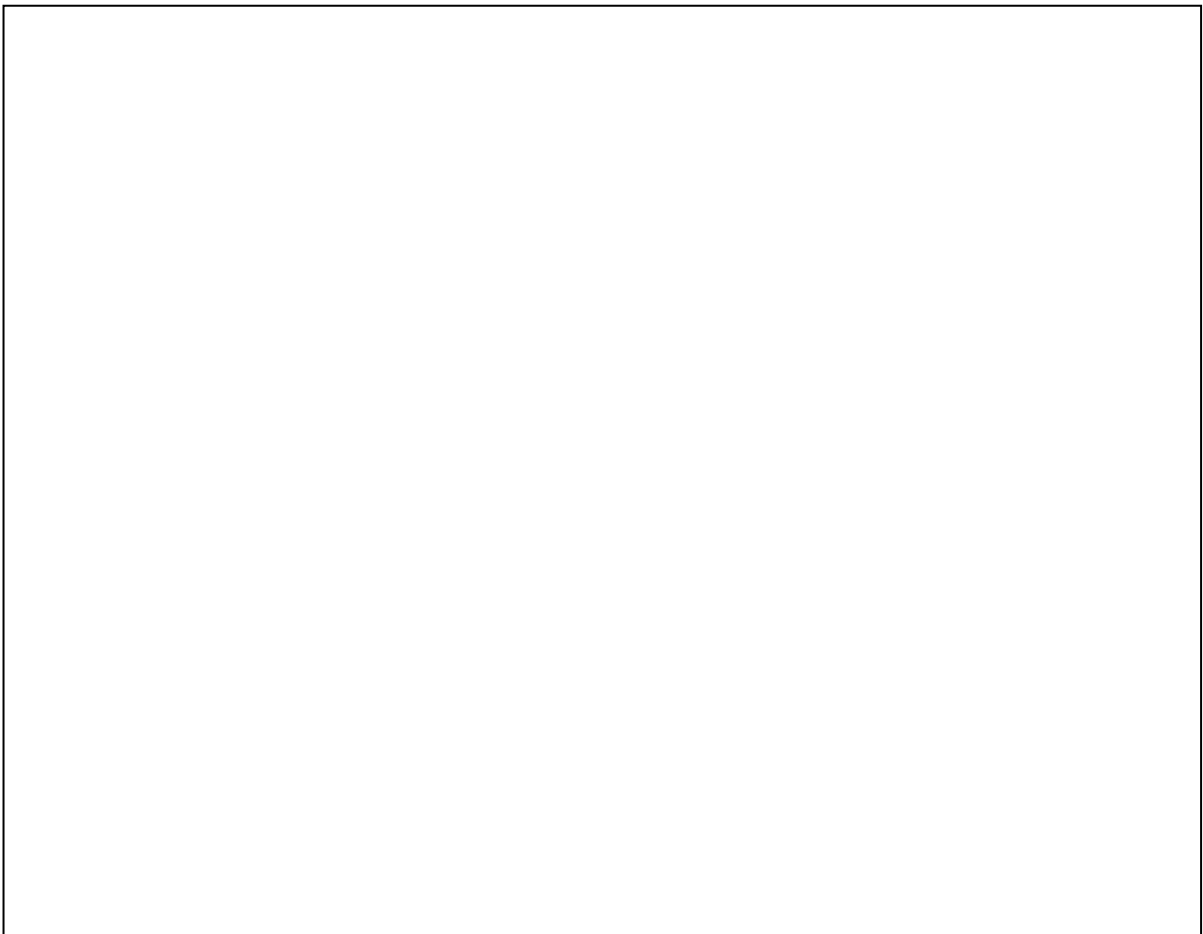
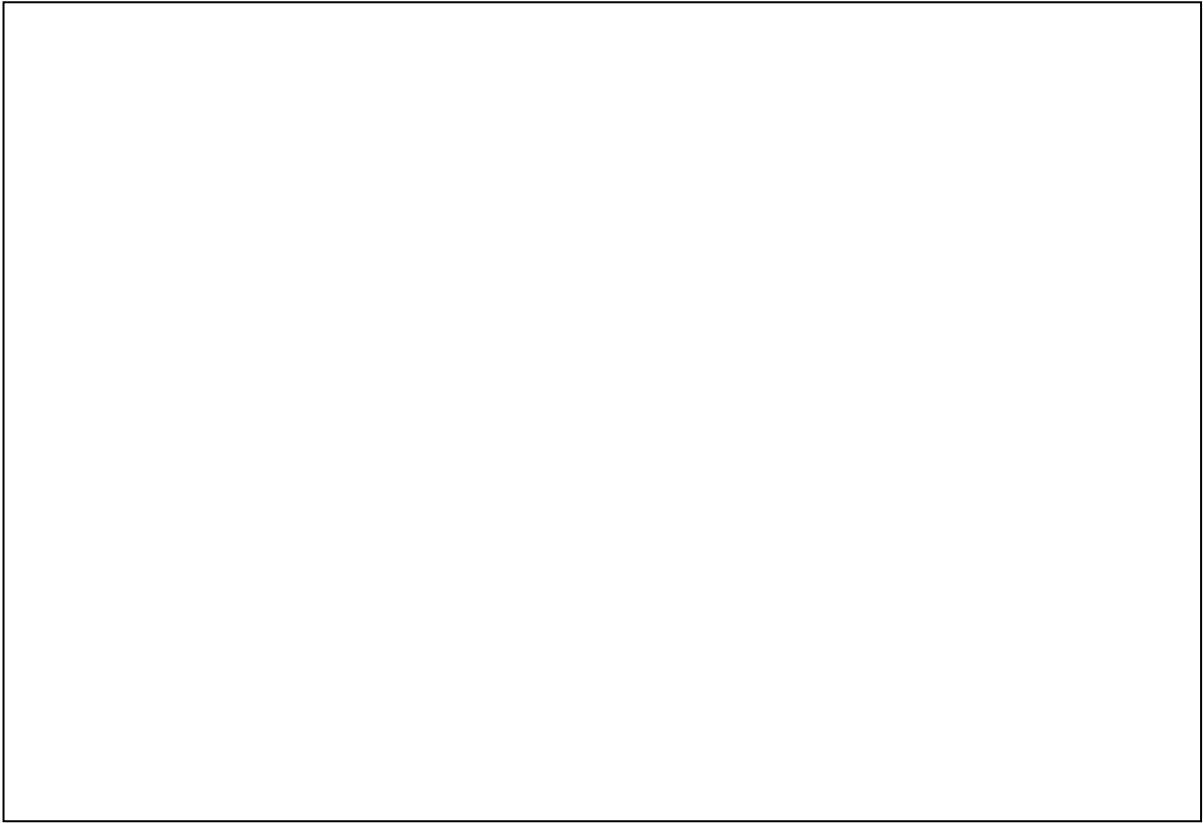

**Experiment No: 14**

**Objective -To study major pests of tea and coffee**

**Exercise** -Identify the pests attacking tea and coffee. Draw a neat diagram of tea mosquito bug and coffee berry borer with their damaging symptoms.

Common name	Scientific name	Family & Order	Damaging symptoms
<b>Pest of tea</b>			
Tea mosquito bug	..... .....	..... .....	..... ..... .....
Red spider mite	..... .....	..... .....	..... ..... .....
Scarlet mite	..... .....	..... .....	..... ..... .....
Pink mite	..... .....	..... .....	..... ..... .....
Yellow mite	..... .....	..... .....	..... ..... .....
<b>Pest of Coffee</b>			
Berry borer	..... .....	..... .....	..... ..... .....
White stem borer	..... .....	..... .....	..... ..... .....
Shot hole borer	..... .....	..... .....	..... ..... .....
Green scale	..... .....	..... .....	..... ..... .....

## Tea mosquito bug and its damaging symptoms

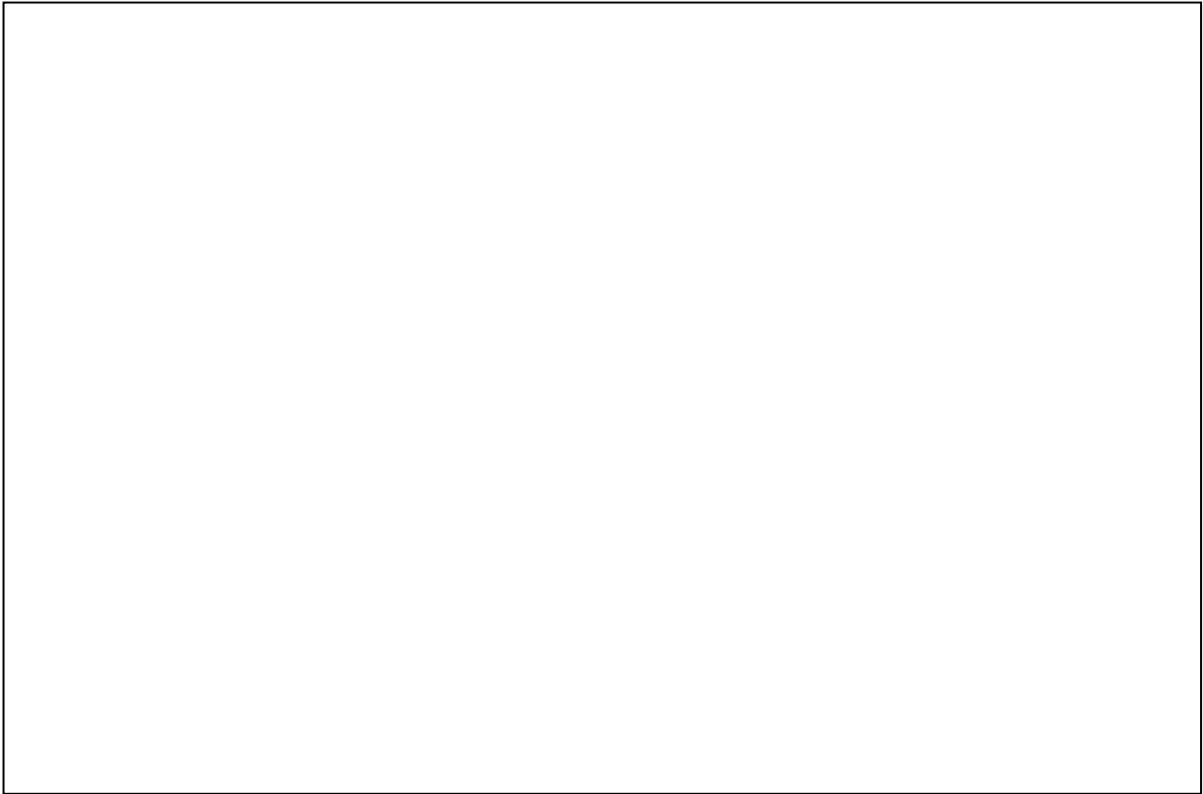



## Experiment No: 15

### Objective - To study insect pests of rubber and cocoa

**Exercise** - Identify the insect pests attacking rubber and cocoa. Draw the different life stages of *Batocera rufomaculata*.

Common name	Scientific name	Family & Order	Damaging symptoms
<b>Insect pests of rubber</b>			
Bark eating caterpillar	..... .....	..... .....	..... ..... .....
Stem borer	..... .....	..... .....	..... ..... .....
Scale	..... .....	..... .....	..... ..... .....
Basket worm	..... .....	..... .....	..... ..... .....
Weevil	..... .....	..... .....	..... ..... .....
<b>Insect pests of cocoa</b>			
Red borer	..... .....	..... .....	..... ..... .....
Fruit borer	..... .....	..... .....	..... ..... .....
Stem girdler	..... .....	..... .....	..... ..... .....
Brown looper	..... .....	..... .....	..... ..... .....

**Different life stages of *Batocera rufomaculata***

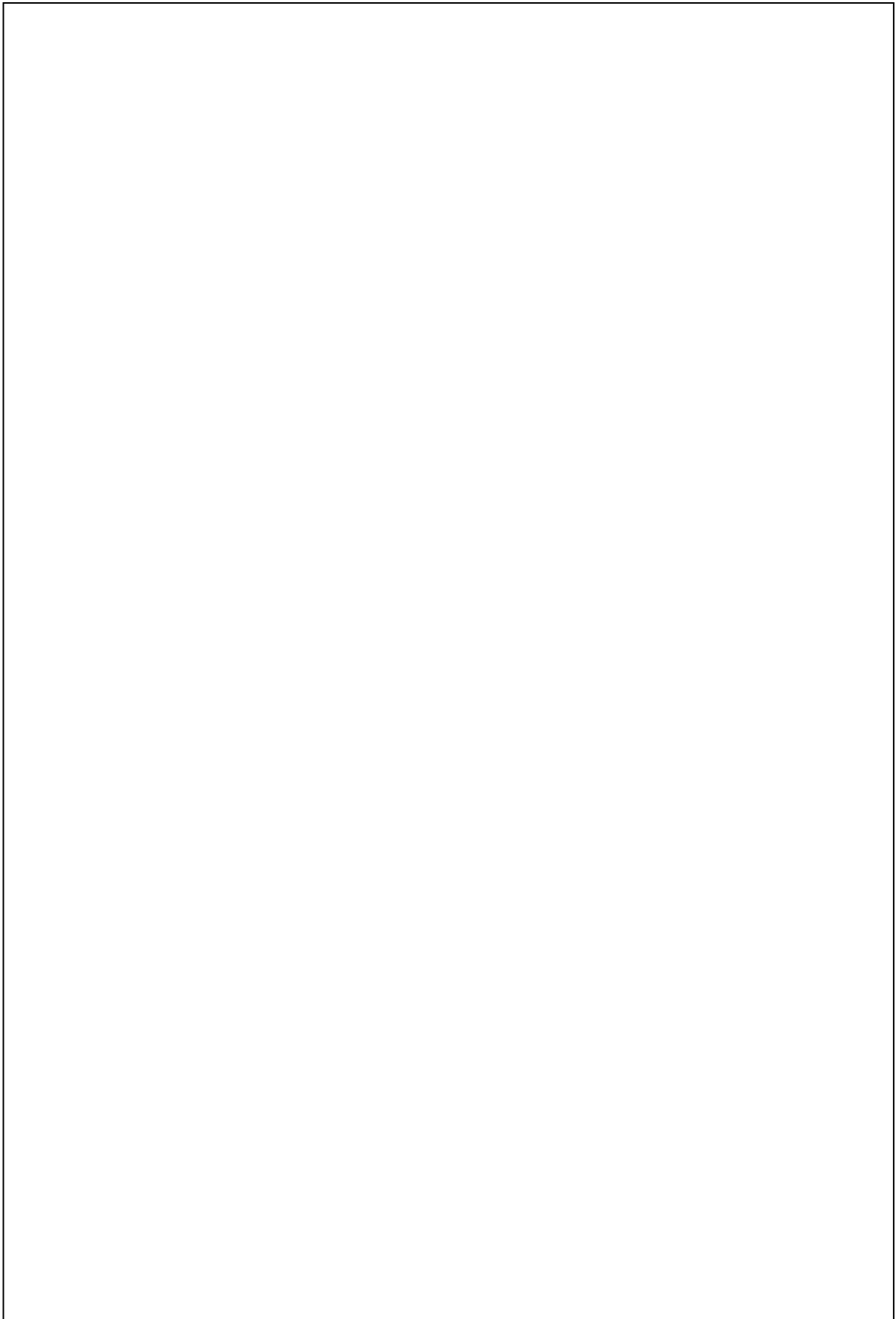

**Experiment No: 16**

**Objective -To study insect pests of betelvine and cashew**

**Exercise -** Write about the insect pests attacking betelvine and cashew. Draw any important pest each of betel vine and cashew.

Common name	Scientific name	Family& Order	Damaging symptoms
<b>Pests of betelvine</b>			
Shoot bug	..... .....	..... .....	..... ..... .....
Scale	..... .....	..... .....	..... ..... .....
White fly	..... .....	..... .....	..... ..... .....
Mealy bug	..... .....	..... .....	..... ..... .....
Giant African snail	..... .....	..... .....	..... ..... .....
Root Knot Nematodes	..... .....	..... .....	..... ..... .....
Red Spider mite	..... .....	..... .....	..... ..... .....

Pest of cashew			
Common name	Scientific name	Family & Order	Damaging symptoms
Stem and root borer	..... .....	..... .....	..... ..... .....
Tea mosquito bug	..... .....	..... .....	..... ..... .....
Shoot and blossom webber	..... .....	..... .....	..... ..... .....
Leaf miner	..... .....	..... .....	..... ..... .....
Apple borer/ chikoo moth	..... .....	..... .....	..... ..... .....

**Pest of Betel vine and Cashew**

**Objective -To get well acquainted with pesticide application techniques**

**Materials Required:** .....

.....

**PESTICIDE APPLICATION METHODS:**

**Dusting:**.....

.....

.....

.....

**Spraying:** .....

.....

.....

.....

**Granular application:** .....

.....

**a. Broadcasting:** .....

.....

.....

**b. Infurrow application:** .....

.....

.....

**c. Side dressing:** .....

.....

.....

**d. Spot application:** .....

.....

**e. Ring application:** .....

.....

**f. Root zone application:** .....

.....

**g. Leaf whorl application:** .....

.....

**h. Pralinage:** .....

.....  
.....  
**Seed pelleting/seed dressing:** .....

.....  
.....  
**Seedling root dip:** .....

.....  
.....  
**Sett treatment:** .....

.....  
.....  
**7. Trunk/stem injection:** .....

.....  
.....  
**Padding:** .....

.....  
.....  
**Swabbing:** .....

.....  
.....  
**Root feeding:** .....

.....  
.....  
**Soil drenching:** .....







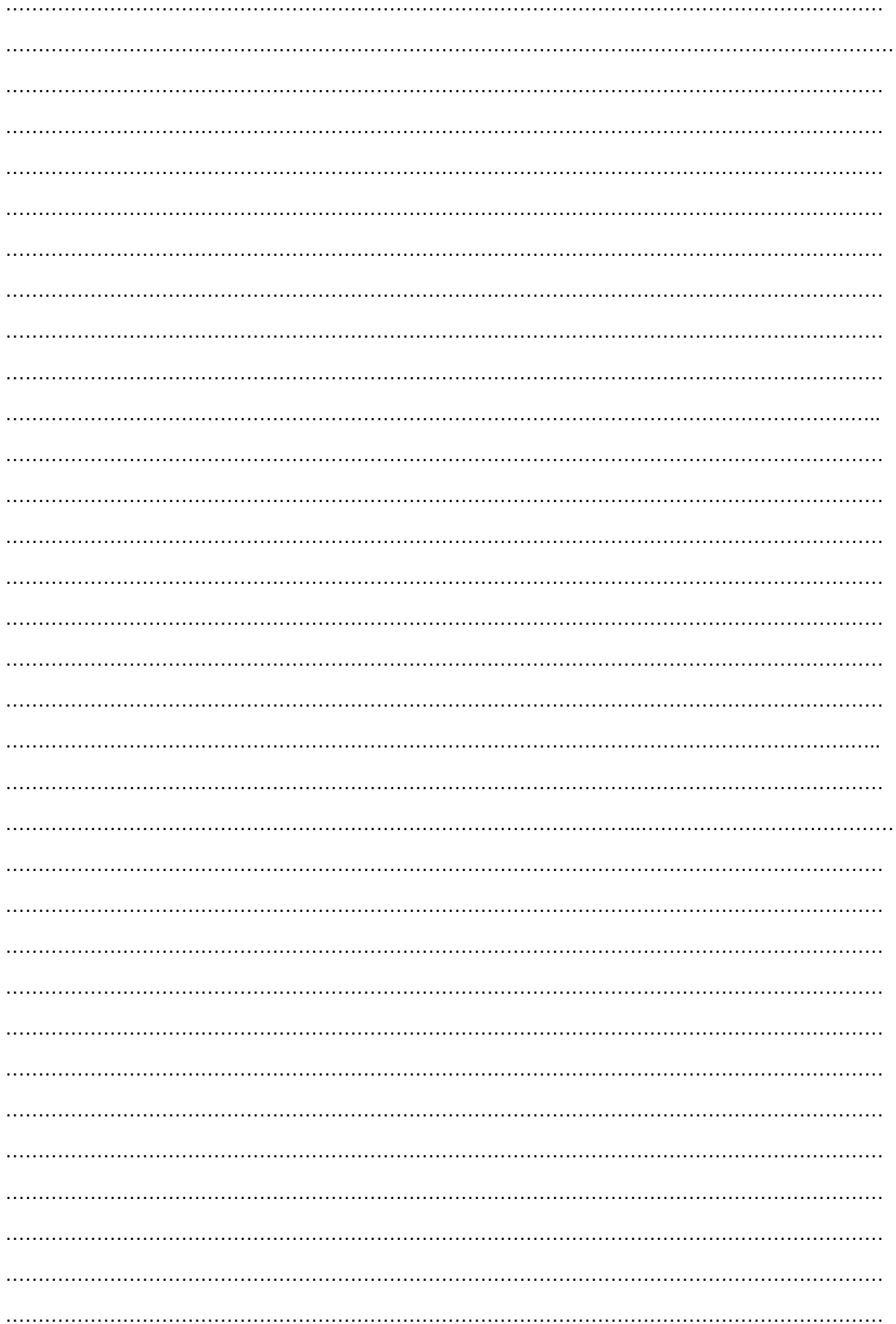

### TYPES OF DAMAGE OF PLANTS BY DIFFERENT INSECT PESTS

Insects inflict injury to plant either directly or indirectly to secure food. Almost all portions of plant viz., roots, stem, bark, leaves, buds, flowers and fruits are attacked. The study of signs/ symptoms exhibited by different parts of the plant due to the damage caused by the insect pests is known as symptomatology. Based on the nature and symptoms of damage, insects can be classified into different groups as mentioned below.

#### Damaged caused by Biting and Chewing Insects

- 1. Stem borers:** Larvae enter into the stem/ tillers and feed on internal contents. As a result, damaged part is cut off from the main plant and affected part wilts, dries up and exhibits symptoms like dead heart/ bunchy top e.g Mango stem borer.
- 2. Shoot borers:** Larvae attack tender shoots and bore inside during the vegetative stage of crop growth and cause wilting, drooping of terminal plant part which later dries up e.g: shoot borers
- 3. Defoliators/ Skeletonizers:** Larvae feed on the leaves completely leaving only midrib/ veins or scrape the chlorophyll content of leaves or cause numerous holes e.g: Banana Rhizome weevils
- 4. Leaf miners:** Larvae mine leaves/ leaflets between the epidermal layers and feed on greenish matter, resulting in the appearance of translucent white patches/ zig-zag galleries on leaves e.g: leaf miners of citrus and cashew.
- 5. Leaf webbers:** Larvae web leaves/ leaflets by means of silken threads and feed on the chlorophyll content by remaining within the web. Often faecal pellets/ frass are found within the web e.g: leaf webbers on sapota, mango and cashew shoot webber.
- 6. Leaf folders:** Larvae fold leaves from tip to base/ longitudinally/ margin to margin there by giving appearance of a fold/ roll

#### 7. Gall makers:

Larvae feeding inside the stem/ tiller/ leaf/ flower bud stimulates excessive growth of cells at the affected portion and distorts normal growth. It results in malformation of plant parts,

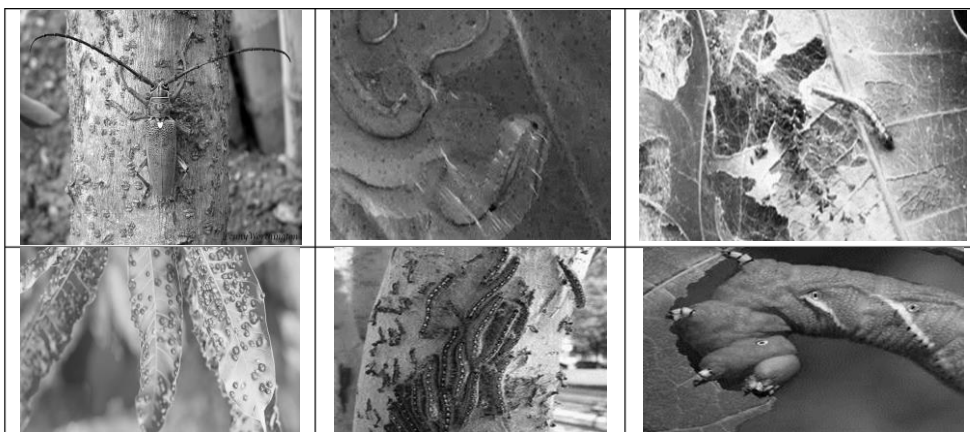

exhibiting gall formation e.g: mango inflorescence midge *etc.*

- 8. Borers:** During the reproductive stage of crop, larva enter into the stem, capsules and feed on the stem holes of different sizes and shapes/ damaged tissues e.g: Mango stem borer *etc.*
- 9. Fruit borers:** Larvae enter into the tender fruits and feed on fresh matter/ pulp and plug the larval burrow with excreta e.g.: Mango stone weevil, cashew, apple and nut borer.
- 10. Bark borers:** Larvae remain in a small tunnel at the axils of branches, under the bark, constructing galleries of frassy web on the stem and near bark/ angles of branches and move about, conceal inside the silken gallery and feed on the bark by scraping e.g: bark eating caterpillars of citrus, mango, guava, casuarinas, jack fruit *etc.*
- 11. Tree borers:** Larvae bore deep into the tree trunk, make the tunnels in zig-zag manner and feed on inner tissues, arresting translocation of sap to top portions of tree, there by the trees exhibit symptoms like yellowing, withering of leaves, drying of twigs or complete drying of tree. Sometimes, gummy material oozes from the affected portion on the tree trunk e.g: Tree borers of mango, cashew, coconut red palm weevil *etc.*
- 12. Root feeders:** Larvae feed on root/ root nodules or nymphs and adults suck sap form the roots resulting in stunted growth/ poor tillering / drying of plants in isolated patches e.g: white grubs, termites, rice root weevil and ragi root aphid.
- 13. From fruits:** Holes, plugged with excreta/ forming necrotic patches/ rotting on fruit e.g: fruit flies, fruit sucking moths.
- 14. Seed feeders (Stored grain pests):** Larvae feed on stored seeds either as internal/ external feeders/ by webbing the food particles e.g: weevil, red rust flour beetle, *etc.*

#### Damaged caused by Sap Feeders

- 1. From inflorescence:** Nymphs and adults suck juice from developing inflorescence resulting in the formation of shriveling e.g: Mango mealy bug.
- 2. From tender plant parts:** Nymphs and adults suck sap from the base of the plant/ leaves/ tender terminal plant parts/

flowers, thereby affect the vigour and growth of the plants e.g. Mango hopper, woolly aphid, banana aphid etc

### Damage symptoms caused by Sucking Insects

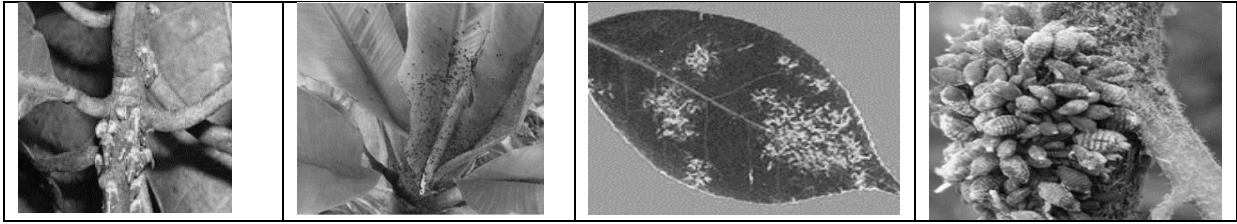

### Sampling techniques for the Assessment of insect Population and Damage

#### Basic need for assessment of insect pests

- To know the extent of pest load and their damage
- To work out economic injury level (EIL) and economic threshold level (ETL)
- To estimate yield loss
- To decide the timing of control measures in order to avoid indiscriminate use of insecticide.

**Estimation of Insect Population:** The type of population estimation will depend on the objectives in view. The estimates are of three types.

**1) Absolute estimates:** The total number of insects per unit area (acre or hectare) is the absolute population. The numbers per unit area of the habitat (per plant, per shoot or per leaf) indicates the density of population. The estimates of absolute population and population density are useful to know and analyze the key mortality factors. The following methods are commonly employed for knowing the absolute estimates.

- 1. Quadrate method:** Small areas or quadrates will be chosen at random from a large area which contains the population. The area of the quadrat relative to the whole area is estimated and also population in the quadrat is known exactly. From a quadrat the insects can be counted or collected directly and their number can be correlated directly with the field population. The reliability of estimates made from this method depends on how representative the quadrates are of the whole population and how close one gets to count the numbers.
- 2. Line-transect method:** In this method a person will walk in a straight line at a constant speed through a habitat, the number of individuals encountered can be counted. The data based on such Encounters can be used in estimating the absolute population of locusts and grass hoppers. The number of encounters is influenced by the speed of person, the speed of individuals comprising the population the distance over which they can be perceived and the density of the population under studies.
- 3. Capture, Marking, Release and the Recapture Technique-** The number of flying insects cannot be assessed by any of the methods described earlier. The capture recapture method can be used for these studies. The losses in a population over a period can be determined with the help of this method. For the effective application of capture-recapture technique in population estimations the following conditions must be satisfied.
  - The marking of individuals should not lead to changes in their behavior or longevity and marks do not get lost easily.
  - The marked individuals after being released becomes completely mixed up with the unmarked individuals of the population.
  - The population is sampled randomly with respect to its mark status.
  - The method of marking should be such as to distinguish between different dates of capture.

**a) Group marking methods:** The most important pre requisite in the technique is that there should be no influence on the longevity or behavior and the natural camouflage of marked individuals. Different marking methods are as follows

- i. Paints and solutions of dyes:** Different colours of paints can be used for marking moths, locusts and grasshoppers, beetles and many other insects. Florescent pigments with gum Arabic glue can also be used.
- ii. Dyes and fluorescent substances in powder form:** The hairy insects can be marked by dusting them with various dyes.
- iii. Labels:** The locusts and butterflies have often been marked by attaching small labels as a part of their wing.
- iv. Mutiliation:** Clipping the wings of lepidopterans, damaging the elytra of beetles by incising edges or cutting small holes are some of the examples.
- v. Radioactive isotopes:** There are two methods of marking with isotopes. Those may be used as labels outside the organism or alternatively can be fed and incorporated in the tissues radioactive metals such as, cobalt (Co60) and Tantalum (Ta182) are widely used. In recapture studies the marked individuals can be detected by the use of Geiger Muller tube or by autoradiography.

**b) Individual marking methods:** In these methods individuals are marked singly and they provide good information on the longevity and dispersal of marked individuals. In involves the use of small labels which may be attached to wings or by having a combination of spots in various positions on the body and by the use of different colours.

**II. Relative estimates:** In these estimates the population is measured in indeterminate units which allow comparison. The relative estimates are obtained by catch per unit time by using various traps. Various types of collection nets are available for use in different habitats and the sweep net is most widely used for sampling the insects from vegetation. Only those individuals on the top of the vegetation and those that do not fall off or fly away on the approach of the collector can be caught with a sweep net. Various traps like, flight aquatic traps, pit fall trap, light trap can be used to collect insects and their trap catch can be correlated with the actual population existing in the field.

**III. Population indices:** In this type the bio products of pests such as exuviae, nests, webs, frass or their effects (damage to the host) are considered instead of pests themselves.

**Estimation of Insect Pests Damage:** A species that interferes with activities of plant and cause damage to yield is known as pest. The total yield losses by different pests to all agricultural crops at global level are estimated to be 42.1% of attainable production. Estimation of crop losses caused by insects to economic crops are exceedingly difficult because,

1. They variable in nature of damage.
2. Insect population fluctuates both in time and space. The nature of damage caused by insect pests of crop plants is a function of pest population. So, it is mostly insect capacity to increase in number rather than the nature of damage.

**Following four points should be kept in view to estimate the losses.**

1. Any insect which cause some kind of the damage to crop can become pest when its population increase above a critical level. The critical level depends upon the nature of the damage caused by the insect e.g. In case of leaf feeders, the leaf eaten is near index of the losses caused by caterpillars. In case of insect vectors of virus of disease, a very small population of infective individuals can spread the disease to whole crop.
2. The losses caused vary both in time and space from 0 to 100%. The estimation is fairly easy at these two extremes, but there are large numbers of factors which tend to invalidate any estimation in between these extreme limits.
3. The loss may be either quantitative or quality. In case of quantitative loss reduced yield is observed, where as in qualitative loss, quality may be affected e.g. In case of mealy bug is known to affect adversely the baking quality of mango.

4. Insect losses in terms of money are also objected. That the selling price of the commodity would be reduced, if insect infestation were to be greater extent. The measures generally followed for estimating the losses caused by insect pests are based on either growing a crop as free from insect infestation as possible and then comparing its yield with that of check crop in which insect activity has been normal, or by making use of differential infestation and comparing the yield. The above ones are used in the following methods for estimating the crop losses. **The methods are as follows,**

**1. Mechanical protection of fruit plant from insect pest damage:** The crop is grown under the enclosures of wire gauze or cotton cloth. These enclosures keep the pest away from the plant. Then, the yield of crop plant under such enclosures is compared with the yield obtained from the infested crop under similar conditions. This technique has been used with that various modifications for estimating the losses caused by hoppers to mango

**2. Chemical protection of the crop:** The crop plant is protected from pest damage by best scheduled chemical recommendation of pesticides. Then, the yield of treated crop plant is compared with that subjected to normal insect infestation. This technique has been very widely used and it can be adopted on a large scale in cultivator's field.

**3. Comparison of yields in different fields having different degrees of pest infestation:** The yield is determined per unit area in different fields having different degrees of pest infestation. The correlation between the yield and degrees of infestation is worked out to estimate the loss in yield.

**4. Comparison of the average yield of healthy plants with that of attacked plants:** In this process individual plants from the same field are examined for the pest incidence and their yield is determined individually. The loss in yield is estimated by comparing the average yield of healthy plants with that of plants showing different degrees of infestation. The same data can also used for working out the correlation between the yield and infestation on the basis of infested individual plants.

**Pradhan and Prasad** worked out the correlation between damage by Mango mealy bug and the yield of mango in the following equation;

$$Y = 6.6204 X_1 - 0.9257X_2 - 27.17$$

Where,

Y = Yield of mango per plant

X<sub>1</sub> = Number of infested inflorescence or fruit per plant

X<sub>2</sub> = Percentage of inflorescence length infested

5. **The average amount of damage caused by individual insect:** For this method, the preliminary information is obtained from studies on biology of the pest species. The details regarding the amount of damage caused by different stages or stages of the insect, and the exact nature and amount of loss caused are then worked out e.g. It has been estimated in the case of locust. It consumes on average 2 kg of green leaves of mango during its life time. It was estimated that this insect would cause 80% loss in yield of mango at a population level of 10 locust per square yard.

**6. Simulated damage:** Many investigators have attempted to simulate pest injury by removing or injuring leaves or other parts of the plant. The simulated damage may not always be equivalent to the damage caused by an insect. Insects may persist over a period of time or inject long acting toxins rather than producing their injury. Feeding on margins of leaf may not be equivalent to tissue removal from the centre of the leaves. Insect feeding is usually extended over a period of time and is difficult to incorporate the concept of rate of injury e.g. simulated damage studies have been conducted on the stem borer.

$$\% \text{ drying branches} = \frac{\text{Number of drying branches}}{\text{Total number of branches}} \times 100 \text{ (ETL 10\%)}$$

**2. Inflorescence midge:**

$$\% \text{ Infected shoot} = \frac{\text{Number of infected bud}}{\text{Total number of bud}} \times 100 \text{ (ETL 10\%)}$$

**3. Leaf Webber:** Based on damage - folded and scrapped leaves

$$\% \text{ leaf damage} = \frac{\text{Number of damaged leaves}}{\text{Total number of leaves}} \times 100$$

### COLLECTION, IDENTIFICATION AND PRESERVATION OF INSECT PESTS

**Aim** - collection of insect pest specimens is important for taxonomic research, ecological studies, bio-assessment and bio-monitoring, and physiological and genetic studies.

**Basic Requirement for collecting insect pests**

**1. Hand picking:** This method is suitable for large insects like beetles and grasshoppers. It is a tedious method. It is unsuitable for insects inflicting painful bites and stings.

**2. Insect net:** There are two types of insect nets.

i. **Aerial net:** (Butterfly net) It is light in weight. It is useful for catching active fliers like moths, butterflies, dragonflies, flies, wasps, etc. The net consists of three parts viz., hoop, handle and porous cloth bag made out of mosquito netting material. It has a small hoop (30-40 cm dia.) and a long handle (100 cm). The diameter of the hoop and the depth of the bag should be in the proportion of 1:2. This net can be home made by using an old badminton racket.

ii. **Sweep net:** This is heavier than the aerial net. It consists of a short handle, a large hoop and a muslin cloth bag. This is suitable for collecting leafhoppers, grasshoppers and other small insects. The net is swept over vegetation. The handle is turned by quick turn of the wrist to fold the cloth bag over the hoop in order to prevent the escape of trapped insects.

**3. Aspirator (Pooter):** Device useful to collect small insects into a vial with no damage to the specimens. It is also useful for collecting insects from the insect net or any other surface. Usually a long glass tube bent at one end and other end attached to a rubber tube, can be used as aspirator. To prevent entry of insects in to mouth a small cloth piece is kept in between the glass and rubber tube.

**4. Traps:** Traps can be used for collecting different types of insects.

- Food lure trap - Flies
- Sex lure trap - Moths
- Water trap - Brown plant hopper
- Light trap - Positively phototropic insects
- Sticky trap - White flies

**II. Killing:** Killing should be done immediately after capture. Potassium cyanide, ethyl acetate, carbon tetra chloride (carbona) and chloroform are commonly used for killing insects. Potassium cyanide kills the insect quickly but rigor mortis sets in quickly. cyanide is a deadly poison and must be handled with extreme care. Ethyl acetate kills the insects more slowly and does not last long. But the dead insects remain in a relaxed condition for a longer time without becoming brittle.

**Preparation of killing bottles:** Killing bottle preparation should be done in a well-ventilated room.

**i. Ethyl acetate killing bottle**

1. Pour 1/2-inch layer of wet plaster of Paris to the bottom of a bottle.
2. Allow it to dry thoroughly (The drying process may be quickened by keeping the bottle inside an oven)
3. Saturate the plaster of Paris layer with ethyl acetate
4. Recharge the bottle with the chemical again as and when it loses its effectiveness

**Dos:**

1. Tape the bottom of the bottle with a few strips of insulation tape to prevent the shattering of the bottle if it is accidentally dropped.

2. Affix a conspicuous 'POISON' label both in English and in vernacular along with the skull and cross bone symbol.
3. Keep the bottle tightly closed to prevent gas leakage.
4. Remove the insects as and when they are dead.
5. Use a separate large killing bottle for moths and butterflies and another for beetles and grasshoppers.
6. Keep the killing bottle in a safe place away from those who are unaware of its deadlines.
7. Dispose the contents of old cyanide bottles preferably by burying it in a pit

#### Don'ts

1. Do not mix small insects with scaly insects.
2. Do not mix delicate and small insects with large insects like beetles and grasshoppers.
3. Do not allow the bottle to sweat
4. Never overload the bottle

iii. **Pinching the thorax:** A butterfly or moth can be immobilised and killed in an emergency by giving a sharp pinch on the thorax.

iv. **Killing with alcohol:** Many insects can be killed by dropping them directly into 70 to 90% ethyl or isopropyl alcohol.

### III Preservation

#### i. Materials required

1. **Paper folds (Paper envelopes):** They are useful for temporary preservation and storage of large winged insects such as dragon flies, butterflies or moths. These triangular envelopes can be made from a sheet of note book or by using absorbent type of paper used in duplicating machines. Cut the paper into rectangles with their sides in the proportion of 3:5. Bring the diagonally opposite corners together to leave two projecting flaps. Write the data regarding collection on the outer side of a projecting flap. Keep the immobilized insect in between the two overlapping triangles. Fold the flaps to produce a triangular envelope.
2. **Setting board (Spreading board):** It is useful for spreading the wings of dead insects. It is a wooden board with a central groove in the middle. Flat cork strips are glued on either side of the groove and in the bottom of the groove to enable pinning. A thermocole sheet with a centrally cut groove can also be used as a substitute for the setting board.
3. **Relaxing container:** Setting or mounting an insect should be done within a day after killing. Otherwise the insect will become stiff and brittle. Stiffness in the dead insect can be removed by placing it in a relaxing container. High humidity inside the relaxing container permits water to be reintroduced into the specimens thus making them flexible.

Fill a container with sand to 1/4th of its capacity. Saturate the sand with water. Add a few drops of carbolic acid or formaldehyde to prevent mold growth. Keep the dried specimens in a small open box or in an uncovered Petri dish to avoid direct contact of the specimen with moist sand. Close the lid tightly and allow them to remain for a day or two until they become flexible.

1. **Pins:** Common pins are undesirable for pinning insects. They are usually too thick and too short. They usually rust or most commonly a green substance called **verdigris** forms where the pin comes into contact with the insect body. Pins used for pinning insects should be slender, hard with a pointed tip and a small head. Pure nickel pins or nickel-plated ones resist rusting. Commonly No.16 and 20 pins are used for pinning larger and smaller insects respectively. **Micro-pins:** For pinning very small insects micropins are used. They are very thin, slender, delicate and headless pins. They do not rust. They are also known as insect pins minuten pins or entomological pins.

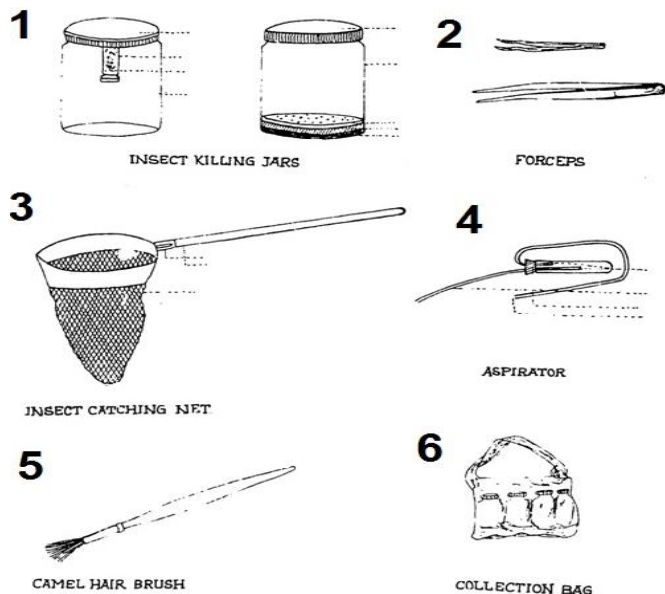

#### ii. Methods of preservation

1. **Pinning:** It is the best and most common method to preserve hard bodied insects. They will dry and remain in perfect condition on the pins without requiring any further treatment. During drying the outer exoskeleton remains intact while the inner soft tissues dry up. Insects can be pinned directly if they are big. They should be pinned in such a way that all important diagnostic characters can be viewed clearly. They are pinned vertically through their body. Depending upon the size of the insect the pin has to be selected. During pinning the insect is held between the thumb and forefinger of one hand and the pin is inserted into the insect with the other hand. While pinning 1/3rd length of the pin should be above the insect to permit a comfortable finger hold. Exact place of insertion of the pin varies among different groups of insects.

### Insects group and pinning position

S. No.	Insect groups	Pinning region
1.	Grasshoppers, crickets, preying mantids and cockroaches	Thorax
2.	Bug	Scutellum
3.	Stick insect	Metanotum
4.	Beetle and weevil	Right elytron
5.	Earwig	Right tegmen
6.	Dragon fly, damselfly, antlion, green, lacewing fly, moths, butterflies, bees, wasps, ants & true flies	Thorax

2. **Double mounting:** Pinning is troublesome in smaller insects. Very small insects cannot be pinned because most of the body parts of the insects will be lost during pinning. For such insects double mounting can be followed.

i. **Staging:** The stage is a narrow rectangular piece of pith or cork. The small insect is pinned correctly with a micropin to the stage. Later the stage is pinned in the insect store box with a bigger pin.

ii. **Carding:** A rectangular (5 x 8 mm or 5 x 12 mm) white card or celluloid bit may be used as stage. On the stage instead of pinning, the insect specimen is stuck on it by using transparent or stain free adhesive. A spot of good glue or white gum can also be used. The insect should not be embedded in the glue and only minimum quantity of the glue should be used. After mounting, the card is pinned to the insect storage box with a large pin.

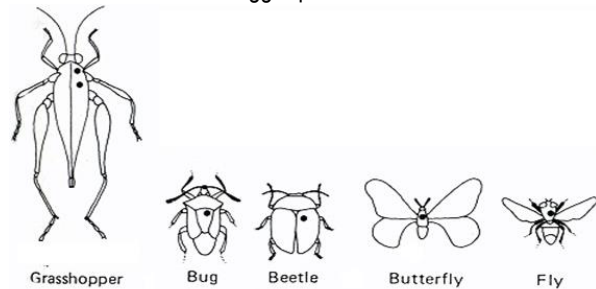

Position of pin hole for proper mounting of common insect orders

iii. **Pointing:** The insect specimen is glued to a card or celluloid bit into a triangle of 10 mm height and 5 mm base. Bend down the tip of the card to form a small surface to which the insect is stuck. Apply a drop of glue or adhesive by touching the point to the glue and to the thorax of the insect to be mounted. Press the right side of the specimen against angled and glued card tip. A bigger pin is inserted at the midpoint near the base for pinning the card with the insect to insect store box.

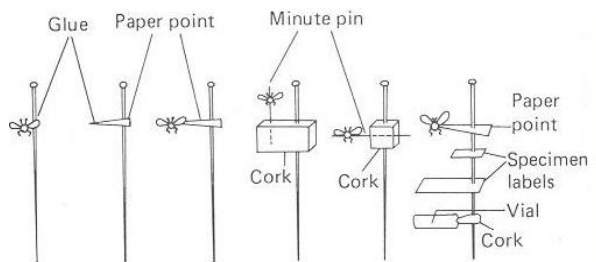

Technique for mounting small insects

3. **Liquid preservation:** Soft bodied forms (nymphs, larvae and many adults) shrivel when mounted dry. Such insects can be preserved in preservative fluids like ethyl alcohol (70%) and formalin (4%). All these preservatives are highly volatile. Screw cap vials are satisfactory if the caps are tight fitting. Sealing the stopper with paraffin wax reduced the evaporation of preservative. Label is written with pencil and placed inside the vial along with the specimen. Careful examination of liquids preserved specimens once in a year is essential to replace the evaporated fluid.

4. **Setting:** Setting insects is essential to study the wing characters. It affords a better look to the preserved specimens. Wings of moths, butterflies, dragonflies and damselflies are set on either side. In grasshoppers, wings on one side alone are set. Setting boards are used for setting insects. Setting should be done before the insects become stiff.

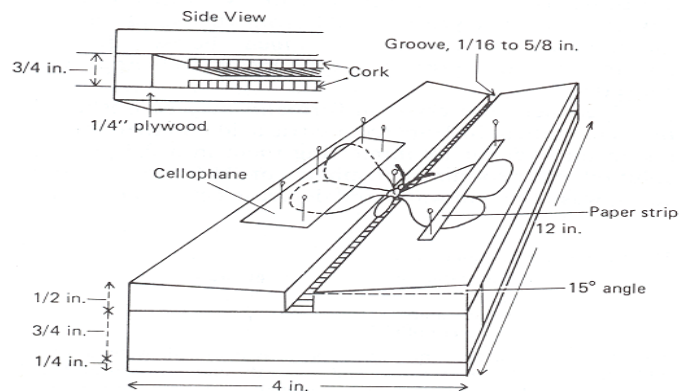

Spreading board used to spread insect wings

5. Pull out the alimentary canal protruding out through the anus by using forceps and cut it off with a razor blade.

6. Insert the syringe needle or the nozzle of the blowing apparatus into the anal slit and fasten by wrapping a thread at the end without puncturing the body.

7. Inflate the exoskeleton gently by pressing the plunger of the syringe or the bulb of the blower until it reaches the normal size. (Avoid too much inflation as this makes the caterpillar grotesque).

8. Keep the inflated caterpillar inside a hot chamber for a few minutes.

9. Gently rotate the caterpillar so that all sides get uniformly heated and turn stiff.
10. Stick the blown-up caterpillar to a match stick with gum or adhesive.
11. Pin it in the insect box through the match stick.

**IV. Labeling:** Labels are must for every collection. Any collection should have a locality label giving particulars about date and locality of its capture. An additional label is often used that usually has the name or initials of the collector and the habitat or host from which the specimen is collected. Labels should be small, (12 x 6 mm) neat and made of stiff paper. Labels may be printed or hand written with micro-tipped pen. They are inserted beneath the insects at 1/3rd height from the base. The long axis of the label should coincide with the long axis of the insect. If more than one label is used then the label should be parallel. All labels should be oriented so that they read from left side.

**V. Display: Insect store boxes:** Commonly wooden boxes of dimension 45 x 30 x 15 cm are used as insect store boxes for displaying preserved insects. The box should be light in weight, air tight and moisture proof with a well-fitting hinged lid. A cell is provided inside to keep repellents. Cork sheets are glued to the inside of the top and bottom of the box to permit pinning. Glass topped boxes can be used for displaying insect collections but the colour of the preserved insects fades due to constant exposure to light.

**Repellents and preservatives:** Preserved specimens are commonly attacked by dermestid beetles, red flour beetle and psocids. Naphthalene balls mounted on pins are pinned inside to repel museum insects. This is done by heating the head of a pin in flame and pressing it against a naphthalene ball. The ball melts at the point of contact. The pin head enters the ball and the melted naphthalene solidifies around the pin head. Naphthalene flakes can also be kept in perforated envelopes and can be pinned in the boxes. In the place of naphthalene, para-dichloro-benzene (PDB) crystals can be used which will not only keep off museum insects but also check their infestation.

**Riker mount:** A Riker mount is a flat container having a glass or transparent cover containing cotton wool and is used for mounting a plant or insect specimen. The name Riker is given after an American botanist. It is useful for displaying various life stages (Blown up caterpillar, empty pupal case and adult of lepidopteron insects). Riker mounts can be used as excellent teaching aids.

#### INSECT PESTS OF MANGO

Common Name	Scientific Name	Destructive Stage	Family	Order
Mango Hopper	<i>Idioscopus niveosparsus</i> , <i>I. clypealis</i> <i>Amitrodes atkinsoni</i>	Nymph and adult	Cicadellidae	Hemiptera
Flower Webber	<i>Eublemma versicolor</i>	Larva	Noctuidae	Lepidoptera
Gall Midge	<i>Erosomyia mangiferae</i>	All at maggot stage	Cecidomyiidae	Diptera
Fruit Fly	<i>Bactrocera dorsalis</i>	Maggot	Tephritidae	Diptera
Mango stone Weevil	<i>Sternonchetus mangiferae</i>	Grub and adult	Curculionidae	Coleoptera
Bark eating caterpillar	<i>Inderbela quadrinata</i> , <i>Inderbela tetranosis</i>	Grub	Inderbelidae	Lepidoptera
Shoot Webber	<i>Orthaga exvinaceae</i>	Larva	Pyralidae	Lepidoptera
Leaf Caterpillar	<i>Euthalia garuda</i>	Larva	Nymphalidae	Lepidoptera
Red ant	<i>Oecophylla smaragdina</i>	Workers	Formicidae	Hymenoptera
Gall Midge	<i>Oligotrophus mangiferae</i>	Maggot	Cecidomyiidae	Diptera
Scale Insect	<i>Chionaspis vitis</i>	Nymph and adult	Diaspididae	Hemiptera
Mango Mealy Bug	<i>Drosicha mangiferae</i>	Nymph and adult	Pseudococcidae	Hemiptera

#### MAJOR INSECT PESTS OF MANGO AND THEIR DAMAGING SYMPTOMS

Insect Particulars	Marks of Identification	Damaging Symptoms
<b>Mango leafhopper</b>	<i>A. atkinsoni</i> : largest light brown with two spots on scutellum. <i>I. clypealis</i> : smallest, light brown with spots on scutellum and a dark spot on vertex. <i>I. niveosparsus</i> : medium sized, with three spots on scutellum and prominent white band across its light brown wings.	<ul style="list-style-type: none"> <li>• Both nymphs and adults suck sap from leaves, tender shoots and inflorescence.</li> <li>• Flower buds, flower etc., first become flaccid then wither and die, leading to reduction in fruit set.</li> <li>• They produce sticky honey dew which encourages the development of sooty mould and which in turn hinders the photosynthetic activity.</li> </ul>
<b>Mango stem borer</b>	<b>Adult:</b> Brownish grey with two pink spots and a pair of lateral spines on thorax. <b>Grub:</b> White, fleshy with dark brown head and strong jaws.	<ul style="list-style-type: none"> <li>• Grubs tunnel through the stem, eating away the nutrition-translocation system and ultimately kill the tree.</li> <li>• Depending on the intensity of attack,</li> <li>• The affected trees show the symptoms like withering of leaves and</li> </ul>



		twigs and drying of entire tree. <ul style="list-style-type: none"> <li>• A white/ yellowish exudate dripping down of the stem indicate the occurrence of stem borer, during its early stage of attack</li> </ul>
<b>Mango stone weevil</b>	<b>Adult:</b> A stout, grayish brown weevil. <b>Grub:</b> White, thick, fleshy and legless.	<ul style="list-style-type: none"> <li>• Grub soon after hatching, burrows into the mesocarp flesh of tender fruit and reaches the region where the endocarp seed coat is still very soft.</li> <li>• Once, the grub crosses this barrier of seed coat, it reaches seed endosperm to complete its life cycle.</li> <li>• In the meantime, the fruit develops and heals up the larval tunnel, so that no external symptom is visible.</li> <li>• Adult, which emerges from seeds, also feeds on seed. This hastens the maturity of infested fruit.</li> </ul>
<b>Mango leaf Webber</b>	<b>Adult:</b> Medium sized, dark brown stout moth. <b>Caterpillar:</b> Slender pale green grows about 35 mm long.	<ul style="list-style-type: none"> <li>• Caterpillar webs terminal leaves and feed by scraping inside.</li> <li>• Leaves are skeletonised.</li> <li>• Flower stalks do not emerge properly</li> </ul>

### MANGO MEALY BUG

#### Mango mealy bug: *Drosicha mangiferae* (Pseudococcidae: Hemiptera)

**Identification of mealy bug** -Mealy bugs are sucking insects, soft bodied, oval shape and cottony in appearance. Mealy bugs are found on leaves, stems, roots and fruits which are covered like whitish powder. Female are wingless and male wing.

**Host range:** Mango, apple, apricot, ber, cherry, Citrus spp., fig, grape vine, guava, jack fruit, jamun, litchi, mulberry and pomegranate.

**Damage symptoms:** 1. Adult bugs are covered with whitish powder and colonize between bark of tree trunk, young shoots and panicles, 2. The nymphs" ascent the trees and settle on inflorescence causing flower drop, affecting fruit set. 3. They also excrete honey dew, a sticky substance, which facilitates development of sooty mould, the mango mealy bugs suck a large amount of sap from all parts of the tree.

#### Biology

**Eggs:** Females lay their eggs directly on the host in a fluted ovisac that is attached to the body of the adult female. Inseminated eggs produce hermaphrodites and un inseminated eggs produce males.

**Nymphs:** The first instars nymphs are also called as crawlers, which are mobile. They settle on the plants, start sucking the sap and form the colonies

**Adults:** In general, they have 4 female instars and 5 male instars, but unlike most other scale insects, the prepupa is quite mobile and although it may have wing buds, the legs and antennae are well developed. Females actually are hermaphrodites that frequently inseminate themselves. Adult males' mate with females, but it is not clear if their sperm are used for reproduction.

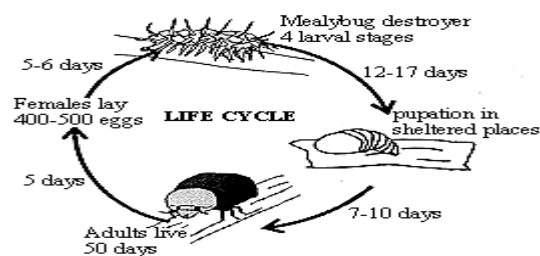

### INSECT PESTS OF GUAVA AND THEIR DAMAGE SYMPTOMS

Insect Particulars	Marks of Identification	Nature and Symptoms of Damage
<b>Tea Mosquito Bug:</b> <i>Helopeltis antonii</i> , Miridae: Hemiptera.	<b>Adult:</b> Reddish with 'T' shaped raised /knobbed process present mid dorsally on the thorax. <b>Nymph and adult:</b> Reddish brown, elongate bug with black head, red thorax black and white abdomen	1.Nymphs and adults make punctures on petiole, tender shoots and fruits 2.Brownish – black necrotic patches develop on foliage 3.Elongate streaks and patches develop on shoots Corky scab formation on fruits
<b>Fruit borer</b> <i>Virachola isocrates</i> , Lycaenidae: Lepidoptera	<ul style="list-style-type: none"> <li>• 1.Caterpillar bores into young fruits</li> <li>• 2.Feeds on internal contents (pulp and seeds)</li> </ul>	<ul style="list-style-type: none"> <li>1. Larvae - dark brown, short and stout, covered with short hairs</li> <li>2. Adult - bluish brown butterfly. Female – V shaped patch on forewing</li> </ul>

<b>Guava Fruit fly ,</b> <i>Bactrocera diversus</i> , Tephritidae: Diptera	<ul style="list-style-type: none"><li>• Adults and maggots attack semi – ripe fruits</li><li>• Oviposition punctures on fruits</li><li>• Maggots destroy and convert pulp into a bad smelling</li><li>• Discoloured semi-liquid mass</li></ul>	Adult - Brown or dark brown with hyaline wings and yellow legs
--	--	--

## GUAVA FRUIT FLY

**Adult** - Brown or dark brown with hyaline wings and yellow legs

**Symptoms of damage:** 1. Adults and maggots attack semi – ripe fruits. 2. Oviposition punctures on fruits. 3. Maggots destroy and convert pulp into a bad smelling. 4. Discoloured semi liquid mass



### Management practices

- Collect and destroy fallen and infested fruits
- Summer ploughing to expose pupa
- Use methyl eugenol lure trap (25/ha) to monitor and kill adults of fruit flies
- Prepare methyl eugenol and malathion 50 EC mixture at 1:1 ratio (take 10 ml mixture/ trap)
- Insecticides: malathion 50 EC 0.05%
- Bait spray combining molasses or jaggery 10g/l and one of the insecticides like malathion 50 EC 2 ml/l, dimethoate 30 EC 1ml/lit, two rounds at fortnight interval before ripening of fruit

## IDENTIFICATION OF INSECT PESTS OF CITRUS AND THEIR DAMAGE SYMPTOMS

Insect Particulars	Marks of Identification	Symptoms of Damage
<b>1. Citrus butterfly:</b> <i>Papilio demoleus</i> L., Papilionidae: Lepidoptera.	<b>Adult:</b> Big, beautiful butterfly with yellow and black markings on fore wings. Hind wings have a brick red oval patch near the anal margin and tail like extension behind. <b>Caterpillar:</b> Dark brown with irregular white markings on their body, when young, changes to deep green colour, when fully grown	Caterpillars feed voraciously on leaves, leaving behind midribs only. In general, they start feeding from the margin inwards, reaching the midrib
<b>Citrus fruit sucking moth:</b> <i>Eudocima maternal</i> L., <i>E. fullonica</i> L., <i>E. ancilla</i> L., Noctuidae: Lepidoptera	<b>Adult:</b> <i>E. maternal</i> : Brown forewings with a white stripe and hind wings with a circular black spot in the middle. <i>E. fullonica</i> : Brown black forewings and yellowish hind wings with kidney shaped black spot. <i>E. ancilla</i> : Cylindrical, stout, semilooper with dark brown velvety colour. <b>Caterpillar:</b> Cylindrical, stout, semilooper with dark brown velvety colour.	Adult moths pierce their proboscis into the fruits and suck the juice. This results not only in fruit drop, but also exposes the fruits to bacterial/ fungal infection due to which fruits rot/ severely suffer in quality.
<b>Bark borer:</b> <i>Indarbela tetraonis</i> Inderbeldae: Lepidoptera	<b>Adult:</b> Medium sized well-built pale brown moth with wavy grey markings on the wings. <b>Caterpillar:</b> Dirty pale brown with dark head and measures about an inch and half in length.	<ul style="list-style-type: none"> <li>• The caterpillars make zig-zag tunnel on the stem, branches and feed on the tissues preferably at fork region.</li> <li>• They make galleries with silken web made up of fine chips of wood and excretory pellets.</li> <li>• Caterpillars move in the galleries at night and spread to other parts.</li> <li>• Such galleries/ ribbons are seen hanging particularly at branches.</li> <li>• Attack is more on older trees in neglected orchards.</li> </ul>
<b>Citrus leaf miner:</b> <i>Phyllocnistis citrella</i> Staint, Gracillaridae: Lepidoptera	<b>Adult:</b> Silvery white with brown striped forewings having a prominent black spot near the tip. Both pairs of wings fringed with hairs. <b>Caterpillar:</b> Yellowish green slender with brownish mandibles.	<ul style="list-style-type: none"> <li>• Caterpillar mines in between the epidermal layers of the leaf in a zigzag manner. As a result, the leaf gets deformed, irregularly curled up in shape, unhealthy in look, defective in its function and finally it dries and falls off.</li> <li>• Sometimes, larvae mine the outer layer of the skin of young</li> </ul>

## ANAR BUTTERFLY

**Scientific Name – *Virachola isocrates*; Family- Lycaenidae; Order- Lepidoptera**

**Identification** –Adult are bluish brown butterfly, Female with V shaped patch on forewing. Full- grown larvae are dark brown with short hair and white patches all over the body and measures about 16 to 20 mm long.

**Host Range** – It is polyphagous pest having a wide range of host plants including Pomegranate, Aonla, Apple, Ber, Litchi, Sapota, Citrus, Guava etc.

**Nature of damage:** The larvae bore into the pomegranate fruits soon after hatching. Once inside the fruit, larvae (approx 2cm length) feed on the flesh and seeds. The bored hole is plugged by the last abdominal segment of the larva. When fully grown, the larva comes out by boring through the hard shell and spins a web, which ties the fruit, stalk to the main branch. Offensive smell and excreta of caterpillars coming out of the **entry holes** with excreta stuck around the holes. The fruits rot and drop off. The holes ultimately expose the rest of the fruit to disease, and typically rot off the tree



**Life cycle** - The pest breeds throughout the year on one fruit or the other. The female butterfly lays shiny white oval shaped eggs singly on the calyx of flowers and on small fruits. The eggs hatch in 1 to 10 days and the young larvae bore into the developing fruit. They feed for 18 to 47 days and when fully grown; they pupate inside the fruit but occasionally may pupate outside even attaching themselves to the stalk of the fruit. The pupal stage lasts for 7-34 days. There are four overlapping generation in a year.

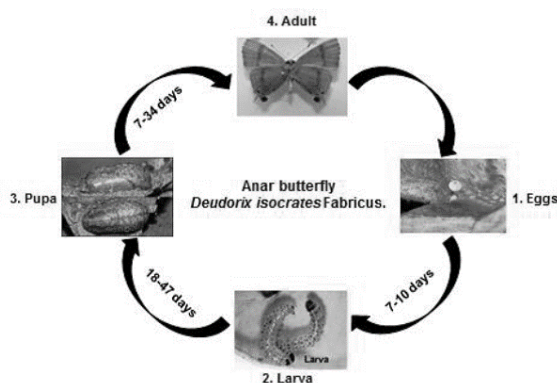

### MAJOR INSECT PEST OF BER

Common name	Scientific name	Family	Order
Ber fruit fly	<i>Carpomyia vesuviana</i>	Tephritidae	Diptera
Ber fruit borer moth	<i>Meridarchis scyroides</i>	Carposinidae	Lepidoptera
Bark eating caterpillar	<i>Indarbela quadrinotata</i>	Cossidae	Lepidoptera
Termite	<i>Odontotermes obesus</i>	Termitidae	Isoptera
Ber stone weevil	<i>Aubeus himalayanus</i>	Curculionidae	Coleoptera

## BER FRUIT FLY

**Scientific name – *Caripomyia vesuviana*; Family – Tephritidae; Order - Diptera**

**Marks of identification:** Adult moth is small and dark brown, Caterpillar is small, dark pinkish to reddish, cylindrical, slightly tapering to both sides

**Host range:** Ber, jamun and olive.

**Nature of damage:** Caterpillar enters the fruit by puncturing a hole in rind and feeds on pulp. Infested fruits drop down, ferment and emit disagreeable odour.

**Biology:** About 11-34 eggs are laid singly in depression near the stalk of fruit and hatch in 4-7 days. Larval development takes place in 13-17 days and pupates in soil. Pupal period is 5-8 days. Adult lives for 3-4 days. Life cycle is completed in 1 month. Pest is carried through shed fruits from one season to other in hibernating larval stage. Activity of the pest is in fruiting season, from September to January and infestation reaches at its peak in middle of November.

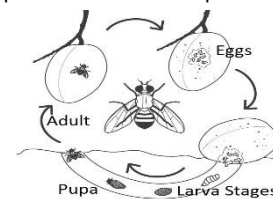

### Management practices

- Removal and destruction of shed fruits.
- Growing of resistant varieties e.g. Surati No.I, Kashi, Mehroon and Mehroon

- Spray with Fipronil 5 per cent @ 75g a.i./ha should be apply.

### BANANA RHIZOME WEEVIL

**Scientific name – *Cosmopolites sordidus*; Family – Curculionidae; Order - Coleoptera**

**Identification:** Adult weevils (10-13mm) are shiny reddish brown to black, with a long and curved snout, elytra short and striated longitudinally. Grubs are creamy white, stout, fleshy, legless, wrinkled and spindle shaped, with red head.

**Hosts Range -** Banana, including all dessert and cooking types, and Manila hemp (*Musa textilis*).

**Nature of damage:** The dark weevil ovipositor in the root stock or leaf sheath just above the ground level. The grubs and adults bore into the rhizome and cause stunting of rhizome development. If the infestation occurs on a mature rhizome, damage symptoms appear through the reduction in the leaf number, bunch size and fruit number. Most damage is done by extensive tunneling of the larvae in the rhizome, thus weakening the plant and causing blow-down by even slight winds. Adult weevil feed during the night on the pseudostem and bore into the suckers.



**Life Cycle:** Adult is stout, reddish brown or shining black weevil and measures about 10-13 mm long. Adults lay eggs in between leaf sheaths and stems as well as round the corm. Often in an enlarged cell-like compartment in the tissue. Eggs hatch in 2-3 days. Eggs are laid singly in root stocks or leaf sheaths just above the ground and the newly hatched larvae bore into the corm or rhizome. Grub period is 25 days. Adults can live over 6 months without food. Adult longevity 2 years.

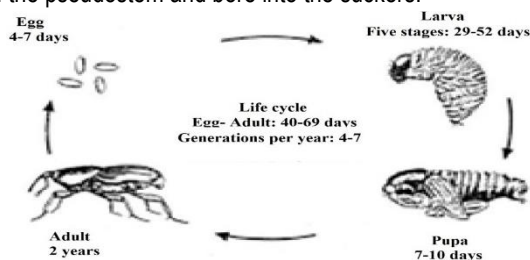

Life cycle of banana weevil under tropical humid conditions

#### Management:

- Select healthy sucker and plant
- Do not take regular crop in the same field to avoid initial infestation
- Ensure clean cultivation
- Removal of pseudo stems below ground level
- Trimming the rhizome
- Trapping: Disc-on-stump traps and old pseudo stem can be used for trapping weevils.
- Grow resistant varieties like Poovan, Kadali, Kunnan, Poomkali
- Use cosmolure trap at 5/ha
- Application of neem powder: Effectively controlled weevils in on farm trials and in farmer's field. Application of 60 to 100 g of neem seed powder or neem cake at planting and then at four months intervals significantly diminished pest damage and increased yields.

### MAJOR INSECT PEST OF AONLA

Common name	Scientific name	Family	Order
Bark-eating caterpillar	<i>Indarbela tetraonis</i>	Metarbelidae	Lepidoptera
Shoot gall maker	<i>Betousa stylophora</i>	Thyrididae	Lepidoptera
Mealy bug	<i>Nipaecoccus viridi</i>	Coccidae	Hemiptera
Leaf rollers	<i>Garcillaria acidula</i>	Gracillariidae	Lepidoptera
Aonla aphids	<i>Cerciaphis emblica</i>	Aphididae	Hemiptera

### BARK-EATING CATERPILLAR IN AONLA

**Symptoms of Damage-** The attack of this pest may be. It is identified by the presence of irregular tunnels and patches covered with silken-web consisting of excreta and chewed up wood particles, on the shoots, branches, and trunk. Shelter holes may be seen particularly at the joints of shoots and branches. The young shoots dry and die, giving sickly look to the tree.

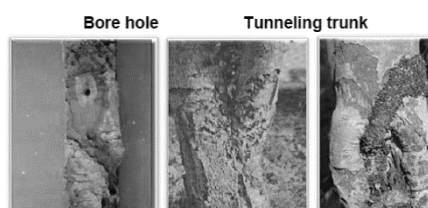

## Management Practices

1. Keep the orchards clean and healthy to prevent the infestation of this pest.
2. Detect early infestation by periodically looking out for drying young shoots.
3. Kill the caterpillars mechanically by inserting the iron spike in shelter holes made by these borers at early stage of infestation.
4. In case of severe infestation, remove webs and insert swab of cotton wool soaked in 0.025% dichlorvos or inject water emulsion of chlorpyrifos (0.05%) and plug the holes.
5. The larvae are parasitized by entomogenous fungus *Beauveria bassiana* in nature. It can be used as a potential bio-control agent

## SHOOT GALL MAKER

**Symptoms of Damage-** In the beginning of the infestation terminal shoots swell, which increases in size with the passage of time. Full size galls can be seen in the month of October-November

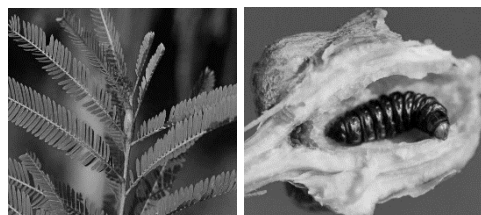

## Management Practices

1. Overcrowding of branches should be discouraged. Galled shoots should be pruned and destroyed along with the pest after harvest.
2. In case of regular occurrence of this pest, spray chlorpyrifos (0.05%) in the beginning of the season. It may be repeated at fortnightly intervals, if needed.

## MAJOR INSECT PEST OF FIG

Common name	Scientific name	Family	Order
Stem borer	<i>Bactocera rufomaculata</i>	Cerambycidae	Coleoptera
Fruit flies	<i>Bactocera</i> spp	Tephritidae	Diptera
Fig midge	<i>Anjeerodiplocis peshawarensis</i>	Cecidomyiidae	Diptera
Mealy bug	<i>Drosicha stebengi</i>	Pseudococcidae	Hemiptera
Scales	<i>Parlatoria oleae</i>	Diaspididae	Homoptera

## INTEGRATED PEST MANAGEMENT

**Field monitoring through traps:** Set up light trap @ 5 traps/ha for monitoring Jassids, stem borer adults, fruit Scales, Fruit fly operate light trap 2-3 hrs after sunset.

### Cultural practices:

1. Racking Of soil around the tree trunks and mixing with some soil dust for the control of early instar of mealy bug in the early part of November.
2. Soil solarization before planting.
3. Prune and destroy affected parts before the onset of monsoon.
4. Maintain plant spacing (5X7 m)
5. White washing of affected trunks can prevent sun burn.
6. Proper water management is advisable to prevent fruit splitting.

### Mechanical Practices:

1. Use light trap @5 traps/ha for collection and killing adults of stem borer from April-July
2. Stem borer and scale infested branches may be cut and destroyed along with larvae.
3. Collection and destruction of infested fruits regularly.
4. A 400 gauge 30 cm wide thick alkathene sheet should be fastened at about 30 cm above the ground level to the tree trunk with the help of thin rope or thread after mud plastering in the month of November to check the ascending first instar mealy bug nymphs.
5. Solution of methyl eugenol, jaggery, malathion 50EC and water in the ratio of 1.0:5.0:2.0:1000 may be hanged at 10-12 places @0.5l/wide mouthed bottle for fruit fly management.

### Biological control

1. **Conservation** -Conserve the parasites and predators like Coccinellids, spiders, reduce bug, predatory thrips, dragonfly, damselfly and wasps which actively suppress the pest population. Avoiding unnecessary sprays are the best way to conserve them.
2. **Augmentation**

1. Release *Chrysoerla carnea* against soft bodied insect @50 grubs/tree up to 5 years old plant and it can be increased later depending upon pest population
  2. Release *Cryptolaemus montrozeeri* and *Chrysoerla carnea* grubs against mealy bug and coccids.
- Biopesticides-** Apply neem cake 80-100 per kg per ha at the time of nursery preparation.

#### PESTS OF COCONUT

Common name	Scientific name	Family	Order
Rhinoceros beetle	<i>Oryctes rhinoceros</i>	Scarabaeidae	Coleoptera
Red palm weevil	<i>Rhynchophorus ferrugineus</i>	Curculionidae	Coleoptera
Black headed caterpillar	<i>Opisina arenosella</i>	Cryptophasidae	Lepidoptera
Coconut Eriophyid mite	<i>Aceria guerreronis</i>	Eriophyidae	Acari
Slug caterpillar	<i>Parasa lipid</i> and <i>Contheyl arotunda</i>	Lamicodidae	Lepidoptera



Rhinoceros beetle

Red palm weevil

#### PESTS OF ARECANUT

Common name	Scientific name	Family	Order
Spindle bug	<i>Carvalhoia arecae</i>	Miridae	Hemiptera
Sorghum orwhite mite	<i>Oligonychus indicus</i>	Tetranychidae	Acari
Palm or redmite	<i>Raoiella indica</i>	Tenuipalpidae	Acari
Root grub	<i>Leucopholis burmeisteri</i>	Melolonthidae	Coleoptera
Inflorescence caterpillar	<i>Tirathaba mundella</i>	Pyralidae	Lepidoptera
Pentatomid bug	<i>Halymorpha marmorea</i>	Pentatomidae	Hemiptera

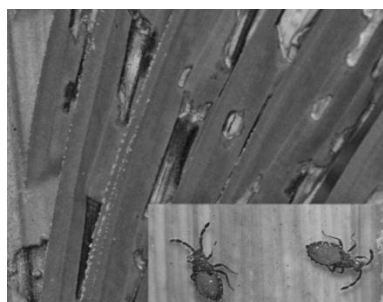

*Carvalhoia arecae*

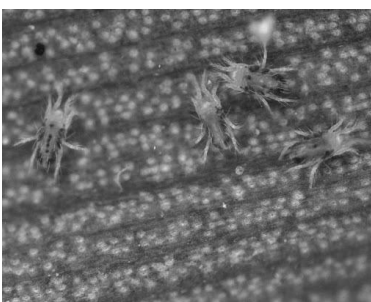

*Oligonychus indicus*

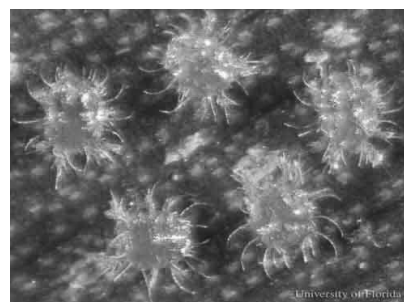

*Raoiella indica*

#### PESTS OF TEA

Common name	Scientific name	Family	Order
Tea mosquito bug	<i>Helopeltist theivora</i>	Miridae	Hemiptera
Red spider mite	<i>Oligonychus coffeae</i>	Tetranychidae	
Scarlet Mite	<i>Brevipalpus californicus</i>	Tenuipalpidae	Acarina
Purple Mite	<i>Calacarus carinatus</i>	Eriophyidae	
Pink mite or Orange Mite	<i>Acaphylla theae</i>		
Yellow mite	<i>Polyphagotarsonne muslatus</i>	Tarsonemidae	
Shot Hole Borer	<i>Euw Wallacea fornicatus</i>	Scolytidae:	Coleoptera
Sapling Borer	<i>Sahyadrassus malabaricus</i>	Hepialidae	Lepidoptera

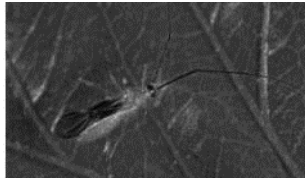

*Helopeltis theivora*



*Euwallaceaf ornicatus*



*Sahyadrassus malabaricus*

### INSECT PESTS OF COFFEE

Common name	Scientific name	Family	Order
White stem borer	<i>Xylotrechus quadripes</i>	Cerambycidae	Coleoptera
Coffee berry borer	<i>Zeuzera coffeae</i>	Cossidae	Lepidoptera
Green scale	<i>Coccus viridis</i>	Coccidae	Hemiptera
Shot hole borer	<i>Xylosandrus compactus</i>	Scolytidae	Coleoptera
Coffee mealy bug	<i>Ferrisia virgata, Planococcus lilacinus, P. citri</i>	Pseudococcidae	Hemiptera

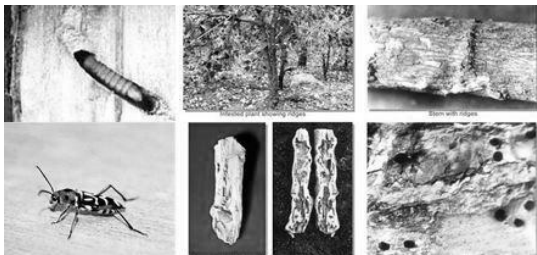

*Xylotrechus quadripes* Damaging symptoms

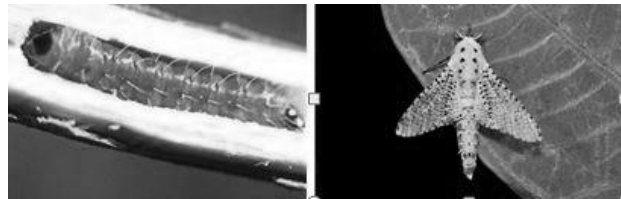

*Zeuzera coffeae*, Larva Adult

### INSECT PESTS OF RUBBER

Common name	Scientific name	Family	Order
Stem borer	<i>Batocera rufomaculata</i>	Cerambycidae	Coleoptera
Scale	<i>Aspidiotus destructor</i>	Coccidae	Hemiptera
Bark caterpillar	<i>Aeherastic circulata</i>	Hyponomeutidae	Lepidoptera
Basket worm	<i>Acantho psychesnelleri</i>	Psychidae	Lepidoptera
Weevil	<i>Apoderus chrysochlorus</i>	Curculionidae	Coleoptera

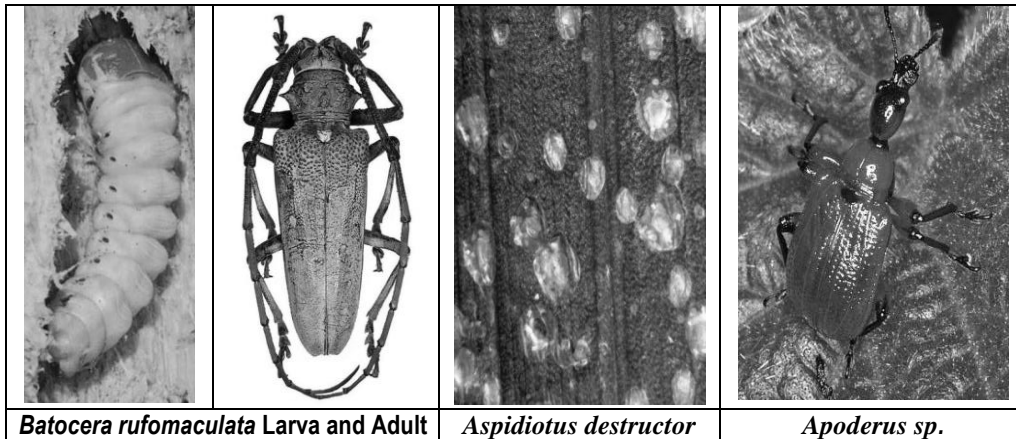

*Batocera rufomaculata* Larva and Adult

*Aspidiotus destructor*

*Apoderus sp.*

### INSECT PESTS OF COCOA

Common name	Scientific name	Family	Order
Red borer	<i>Zeuzera coffeae</i>	Cossidae	Lepidoptera
Fruit borer	<i>Dichocrocis(=Conogethus) punctiferalis</i>	Pyraustidae	Lepidoptera
Stem girdler	<i>Sthenias grisator</i>	Cerambycidae	Coleoptera
Brown looper	<i>Hyposidrata laca</i>	Geometridae	Lepidoptera



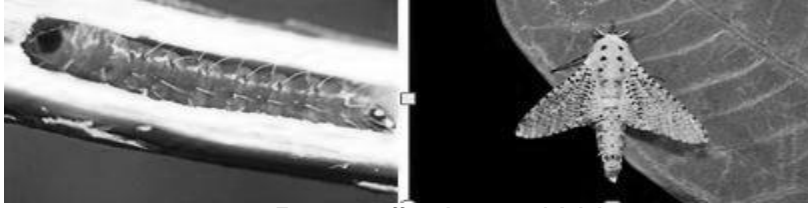

*Zeuzera coffeae* Larva and Adult

### INSECT PESTS OF BETELVINE

Common name	Scientific name	Family	Order
Shoot bug	<i>Pachypeltis politus, P. measarum</i>	Miridae	Hemiptera
Scale	<i>Lepidosaphes cornutus</i>	Coccidae	Hemiptera
White fly	<i>Aleurocanthus nubilans and Dialeurodes pallida</i>	Aleurodidae	Hemiptera
Mealy bug	<i>Geococcus citrinus</i>	Pseudococcidae	Hemiptera
Giant African snail	<i>Achatina fulica</i>	Achatinidae	-
Root Knot Nematodes	<i>Meliodogyne arenaria</i>	Heteroderidae	Tylenchida
Red Spider mite	<i>Tetranychidae cinnaberinus</i>	Tetranychidae	Acarina

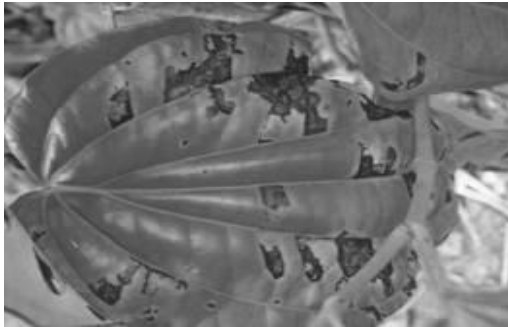

Shoot bug



Giant African snail

### INSECT PESTS OF CASHEW

Common name	Scientific name	Family	Order
Stem and root borer	<i>Plocaederus ferrugineus</i>	Cerambycidae	Coleoptera
Tea mosquito bug	<i>Helopeltis antonii</i>	Miridae	Hemiptera
Shoot and blossom webber	<i>Macallamon cousalis</i>	Pyraustidae	Lepidoptera
Leaf miner	<i>Acrocercops syngamma</i>	Gracillariidae	Lepidoptera
Apple borer/ chikoo moth	<i>Nephoteryx eugraphella</i>	Phycitidae	Lepidoptera



Stem and root borer



Leaf miner



Chikoo moth

### PESTICIDE APPLICATION METHODS

- Dusting:** Dusting is carried out in the morning hours and is suitable for dry land crop pest control.
- Spraying:** EC (or) WP formulations are mixed in water and sprayed. There are three types of spraying.

Types of spraying	Spray fluid (lit/ha)	Droplet size ( $\mu$ )	Area covered per day	Equipment used
High volume	500-750	150	2.5 ac	Knapsack, Rocker sprayers
Low volume	150-200	70-150	5.6 ac	Power sprayer, Mist blower
Ultra-low volume	2-4	20-70	20 ac	ULV sprayer, Electro-dyn sprayer

- Granular application:** Highly toxic pesticides are handled safely in the form of granules. Granules can be applied directly on the soil or in the plant parts. The methods of application are
  - Broadcasting:** Granules are mixed with equal quantity of sand and broadcasted directly on the soil or in thin film of standing water. (eg.) Carbofuran 3G applied @ 1.45 kg/8 cent rice nursery in a thin film of water against nursery pests.
  - In-furrow application:** Granules are applied at the time of sowing in furrows in beds and covered with soil before irrigation. (e.g.) Carbofuran 3G applied @ 3 g per meter row for the control of sorghum shoot fly.
  - Side dressing:** After establishment of the plants, the granules are applied a little away from the plant (10-15 cm) in a furrow.

- d) Spot application:** Granules are applied @ 5 cm away and 5 cm deep on the sides of plant. This reduces the quantity of insecticide required.
- e) Ring application:** Granules are applied in a ring form around the trees.
- f) Root zone application:** Granules are encapsulated and placed in the root zone of the plant. (e.g.) Carbofuran in rice.
- g) Leaf whorl application:** Granules are applied by mixing it with equal quantity of sand in the central whorl of crops like sorghum, maize, sugarcane to control internal borers.
- h) Pralinage:** The surface of banana sucker intended for planting is trimmed. The sucker is dipped in wet clay slurry and carbofuran 3G is sprinkled (20-40 g/sucker) to control burrowing nematode.
- 2. Seed pelleting/seed dressing:** The insecticide mixed with seed before sowing (e.g.) sorghum seeds are treated with chlorpyrifos 4 ml/kg in 20 ml of water and shade dried to control shoot fly. The carbofuran 50 SP is directly used as dry seed dressing insecticide against sorghum shoot fly.
- 3. Seedling root dip:** It is followed to control early stage pests (e.g.) in rice to control sucking pests and stem borer in early transplanted crop, a shallow pit lined with polythene sheet is prepared in the field. To this 0.5 kg urea in 2.5 litre of water and 100 ml chlorpyrifos in 2.5 litre of water prepared separately are poured. The solution is made up to 50 ml with water and the roots of seedlings in bundles are dipped for 20 min before transplanting.
- 4. Sett treatment:** Treat the sugarcane setts in 0.05% malathion for 15 minutes to protect them from scales. Treat the sugarcane setts in 0.05% Imidacloprid 70 WS @ 175 g/ha or 7 g/l dipped for 16 minutes to protect them from termites.
- 5. Trunk/stem injection:** This method is used for the control of coconut pests like black headed caterpillar, mite etc. Drill a downward slanting hole of 1.25 cm diameter to a depth of 5 cm at a light of about 1.5 m above ground level and inject 5 ml of monocrotophos 36 WSC into the stem and plug the hole with cement (or) clay mixed with a fungicide. Pseudo stem injection of banana, an injecting gun or hypodermic syringe is used for the control of banana aphid, vector of bunchy top disease.
- 6. Swabbing:** Coffee white borer is controlled by swabbing the trunk and branches with HCH (BHC) 1 per cent suspension.
- 7. Padding:** Stem borers of mango, silk cotton and cashew can be controlled by this method. Bark of infested tree (5 x 5 cm) is removed on three sides leaving bottom as a flap. Small quantity of absorbant cotton is placed in the exposed area and 5-10 ml of Monocrotophos 36 WSP is added using ink filler. Close the flap and cover with clay mixed with fungicide.
- 8. Root feeding:** Trunk injection in coconut results in wounding of trees and root feeding is an alternate and safe chemical method to control black headed caterpillar, eriophyid mite, red palm weevil. Monocrotophos 10 ml and equal quantity of water are taken in a polythene bag and cut the end (slant cut at 45) of a growing root tip (dull white root) is placed inside the insecticide solution and the bag is tied with root. The insecticide absorbed by root, enter the plant system and control the insect.
- 9. Soil drenching:** Chemical is diluted with water and the solution is used to drench the soil to control certain subterranean pests. (e.g.) BHC 50 WP is mixed with water @ 1 kg in 65 litres of water and drench the soil for the control of cotton/stem weevil and brinjal ash weevil grubs.
- 10. Capsule placement:** The systemic poison could be applied in capsules to get toxic effect for a long period. (e.g.) In banana to control bunchy top vector (aphid) the insecticide is filled in gelatin capsules and placed in the crown region.
- 11. Baiting:** The toxicant is mixed with a bait material so as to attract the insects towards the toxicant.
- a) Coconut rhinoceros beetle: Rotten castor cake 5 kg is mixed with insecticide.
- b) Spodoptera: Bait prepared with 0.5 kg molasses, 0.5 kg carbaryl 50 WP and 5 kg of rice bran with required water (3 litres) is made into small pellets and dropped in the field in the evening hours.
- b) Rats: Zinc phosphide is mixed at 1:49 ratio with food like popped rice or maize or cholam or coconut pieces (or) warfarin can be mixed at 1:19 ratio with food. Ready to use cake formulation (Bromodiolone) is also available.
- 12. Fumigation:** Fumigants are available in solid and liquid forms. They can be applied in the following way.
- a) **Soil:** To control the nematode in soil, the liquid fumigants are injected by using injecting gun.
- b) **Storage:** Liquid fumigants like Ethylene dibromide (EDB), Methyl bromide (MB), carbon tetrachloride etc. and solid fumigant like Aluminium phosphide are recommended in godowns to control stored product pest.
- c) **Trunk:** Aluminium phosphide is inserted into the affected portion of coconut tree @ 1 tablet / tree for the control of red palm weevil and into live burrows @ 2 tablets / tree to control rats, and plugged with cement or mud.

### PESTICIDE DOSAGE CALCULATION

The following formulas are useful in quantifying insecticides for field application.

#### 1. For spraying

Preparation of spray solution is  $V_1S_1=V_2S_2$

Where  $V_1$  = volume of insecticide required;  $S_1$ = strength of the commercial formulation

$V_2$  = volume of spray fluid required;  $S_2$  = strength of the spray fluid.

#### 2. For granular application

Quantity of chemical needed

$$= \frac{\text{Recommended a.i./ha}}{\% \text{ a.i in the formulation}} \times 100$$